

2025

About us	Our philosophy	06
Acoustic	Nexus	08
	Helix	14
	Mone	20
	Orbit	46
	Halo	56
	Turbo	66
	Sonic	72
	Even	90
	Ampra	96
	Foamy	112
Technical information	Finishes	106

Our mission is healthy light

The ILUM brand fulfills its mission by delivering unparalleled lighting projects that prioritize human comfort in both work and leisure environments. Our cutting-edge approach to design creates innovative and health-conscious lighting for everyday life. The key factors shaping ILUM's brand are deeply rooted in the surrounding nature. Crafted by eminent designers for designers, our brand stands at the forefront of the contemporary lighting industry, collaborating with revered figures in the design scene. Our product portfolio boasts distinct individuality, with each project showcasing

unique characteristics. The Ogi family draws inspiration from timeless Japanese culture, while the enigmatic Juicy is adorned with minimalist hats, and the sophisticated Stellar beckons with its enchanting natural veneer. Beyond aesthetics, each product stands out for its advanced technology tailored to the specific needs of each family. The seamless integration of technological innovation, original design, and unwavering quality creates truly natural lighting that enhances daily comfort for humans, making ILUM a reliable source of daily well-being.

Harmony of Light and Acoustics

The Nexus acoustic luminaire is a modern solution designed for spaces where both visual and acoustic comfort matter. It combines two complementary types of lighting, responding to diverse user needs and the character of the interior. Soft, diffused light creates a welcoming atmosphere and supports concentration,

providing optimal conditions for work or relaxation. This is complemented by a precise spotlight that allows for intentional light control, with an adjustable beam angle ranging from 30 to 55 degrees — ideal for highlighting selected zones or architectural details.



Nexus

Collection

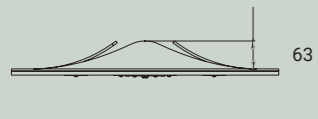

600

Nexus

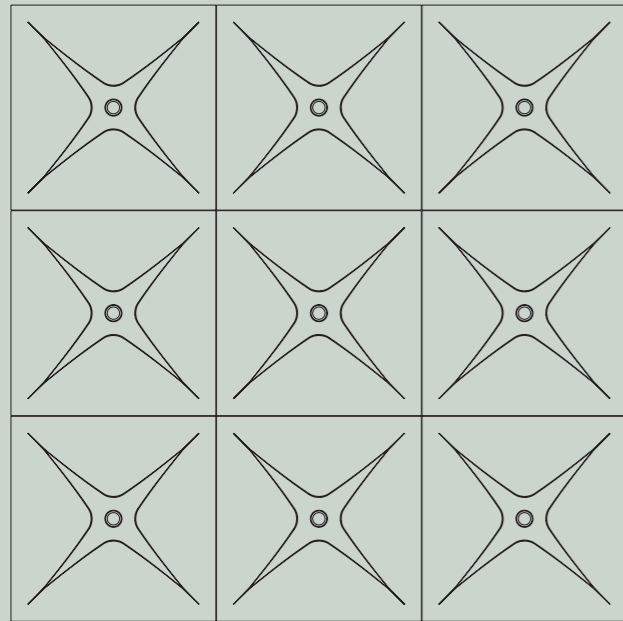
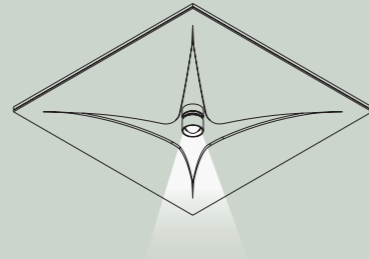

An added value of the Nexus luminaire is its acoustic function, which enhances sound comfort by reducing reverberation within the space. This harmonious

combination of design, technology, and functionality makes Nexus an ideal choice for offices, public spaces, and contemporary commercial interiors.

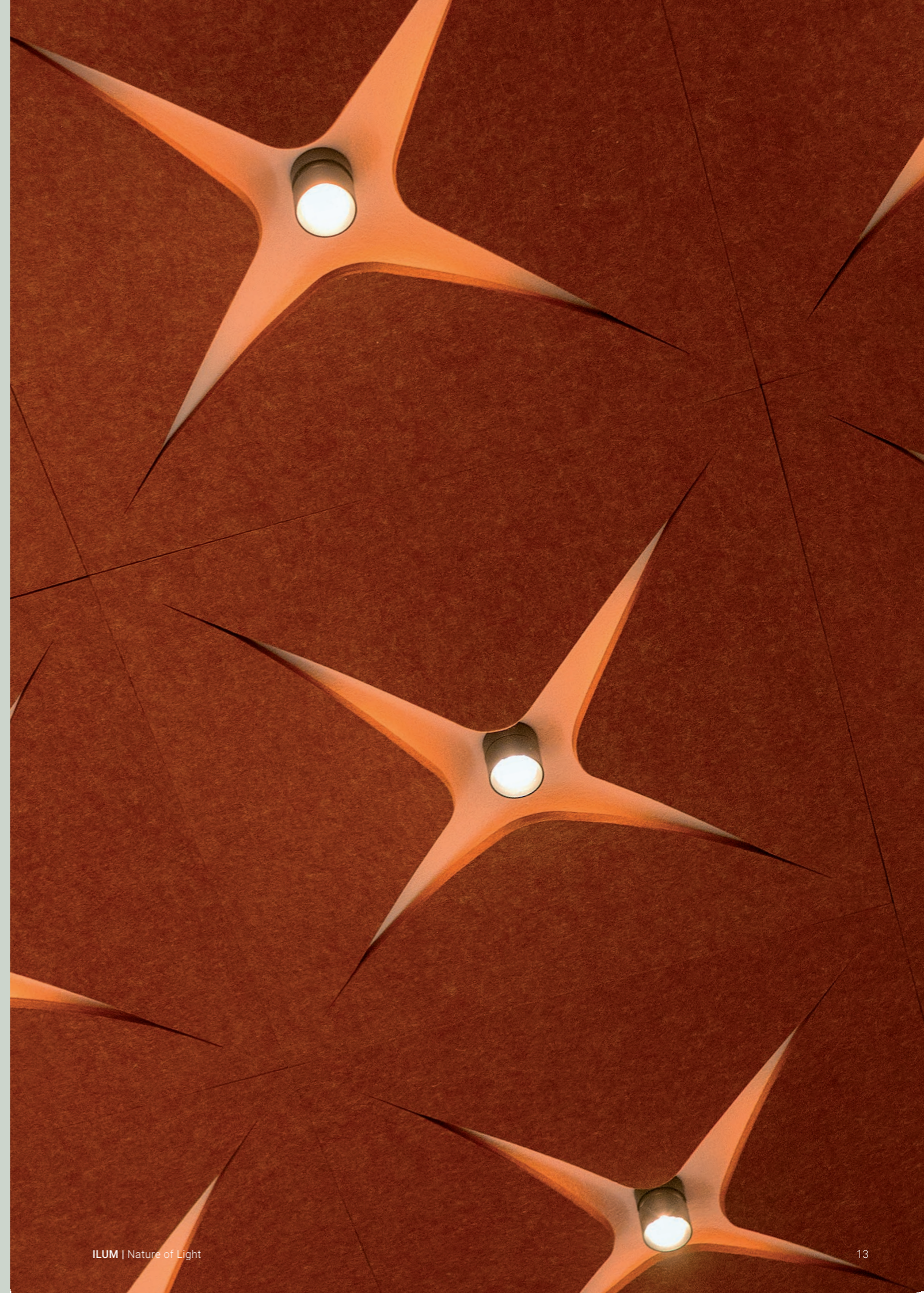

Perfect harmony of light and silence

Helix redefines lighting in modern interiors—a solution that combines advanced technology with minimalist aesthetics. Thanks to its innovative optical design, the fixture precisely concentrates the light beam and then distributes it evenly and almost imperceptibly throughout the space. The result? Subtle, soft

illumination with no visible light source, creating atmosphere and enhancing the architecture of the interior rather than dominating its character. Helix enables a conscious approach to lighting design—highlighting details, shaping space, and creating comfortable conditions for both work and relaxation.



Helix Collection



600

Helix
600

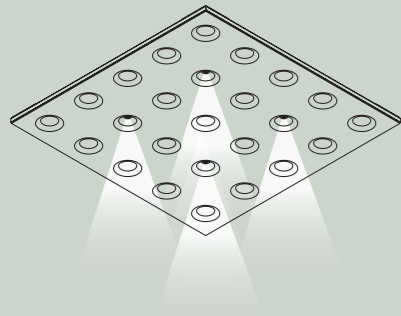

Helix
600

However, it is more than just lighting. The system is enhanced with a specially designed ceiling-mounted acoustic frame made of PET felt, tailored to meet the needs of contemporary spaces such as offices, conference rooms, and public areas. This material effectively absorbs sound, reduces reverberation, and improves the acoustic quality of the environment. As a result, the interior becomes not only better lit but

also significantly more comfortable to experience. The seamless integration of light and acoustics allows Helix to create a harmonious environment where design meets functionality. It is a solution for those who expect more—technology that works discreetly in the background while significantly enhancing the overall quality of the space.





Acoustic comfort

Mone is a high-performance acoustic fixture that combines exceptional sound absorption with advanced lighting capabilities. Its distinctive ribbed lampshade houses a multicone light source, providing focused spotlight illumination. The design is further

enhanced by ambient lighting in three color options, gently highlighting the layered felt structure for added visual elegance. Available in four variants, Mone offers customization in a range of colors and shapes to suit wide range of open spaces.



Mone Collection



350

655

Mone
Flat S

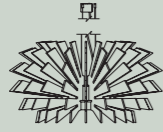

520

980

Mone
Flat M

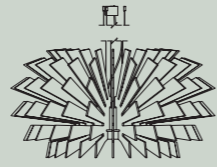

695

1305

Mone
Flat L



350

655

Mone W
Flat S



520

980

Mone W
Flat M



695

1305

Mone W
Flat L



520

535

Mone
Oval S

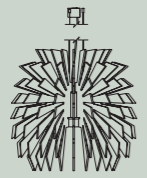

775

810

Mone
Oval M

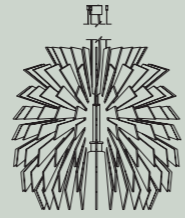

1035

1080

Mone
Oval L



520

535

300

Mone W
Oval S

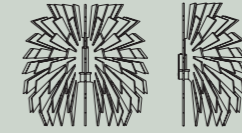

775

810

435

Mone W
Oval M

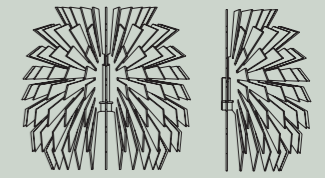

1035

1080

570

Mone W
Oval L

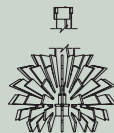

385

550

Mone
Round S

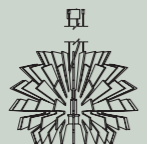

590

825

Mone
Round M

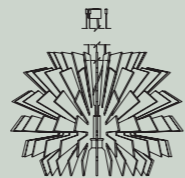

770

1105

Mone
Round L



385

550

310

Mone W
Round S



590

825

445

Mone W
Round M

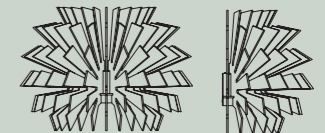

770

1105

585

Mone W
Round L



630

605

Mone
Punk S

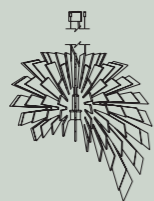

950

910

Mone
Punk M

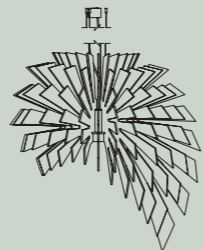

1265

1215

Mone
Punk L



630

605

260

Mone W
Punk S

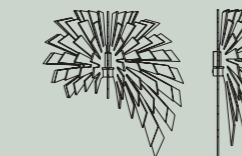

950

910

375

Mone W
Punk M

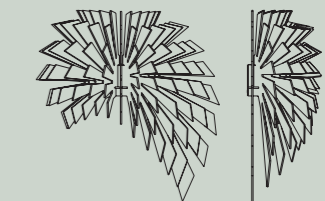

1265

1215

495

Mone W
Punk L

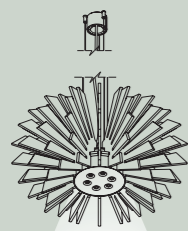

Mone
Flat S

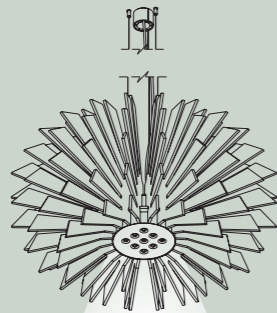

Mone
Flat M

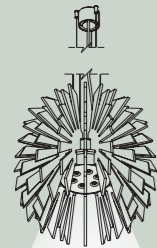

Mone
Oval S

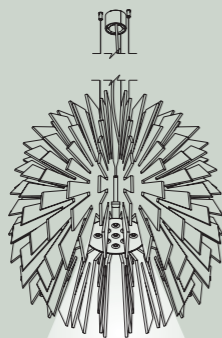

Mone
Oval M

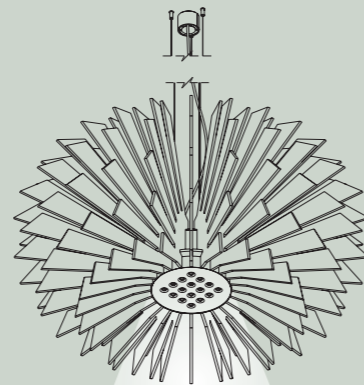

Mone
Flat L

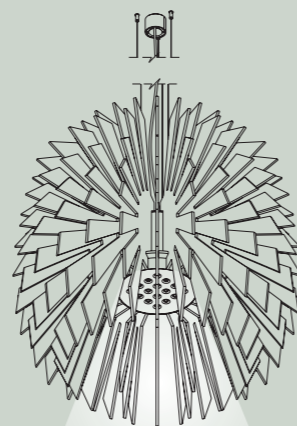

Mone
Oval L

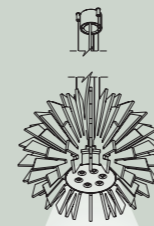

Mone
Round S

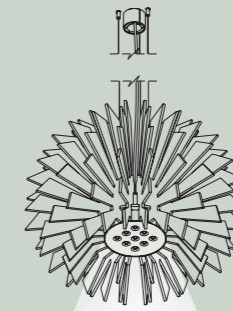

Mone
Round M

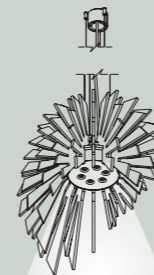

Mone
Punk S

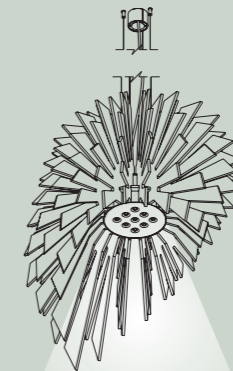

Mone
Punk M

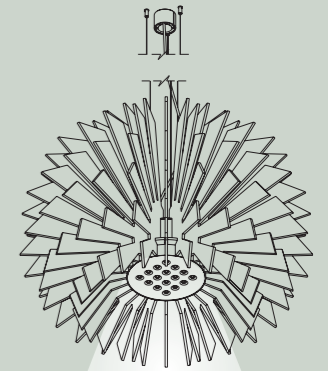

Mone
Round L

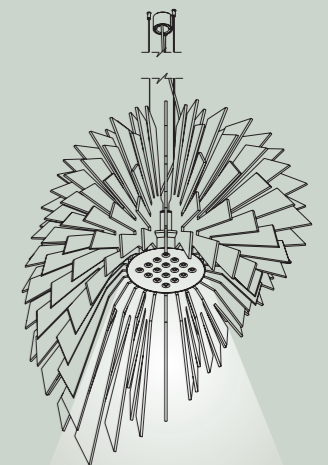

Mone
Punk L

Mone seamlessly integrates exceptional acoustic performance with superior lighting quality, creating a harmonious balance of functionality and ambiance. We have thoughtfully incorporated our innovative multicone light technology into the design, delivering

a versatile and high-quality task lighting solution that enhances any space. This combination ensures not only optimal sound absorption but also precise, lens-based illumination, making Mone an ideal choice for wide open commercial spaces as well as offices.

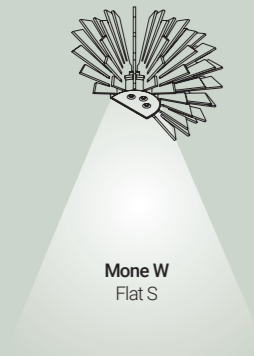

Mone W
Flat S

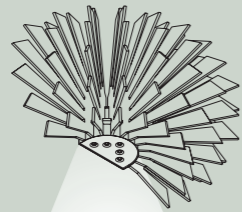

Mone W
Flat M

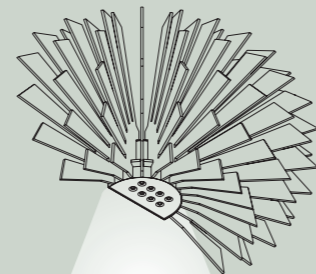

Mone W
Flat L

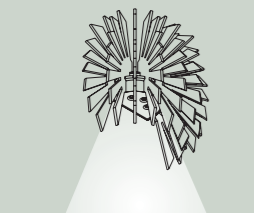

Mone W
Oval S

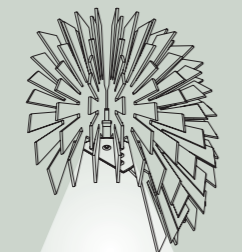

Mone W
Oval M

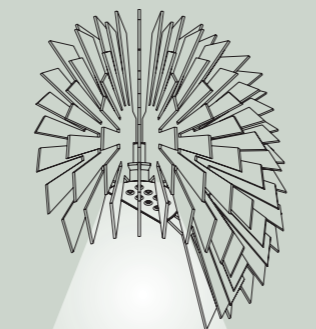

Mone W
Oval L



Mone W
Round S

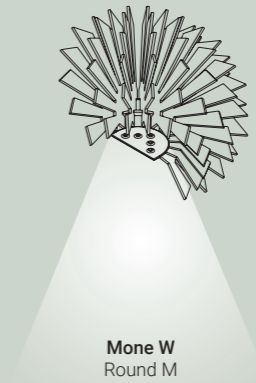

Mone W
Round M

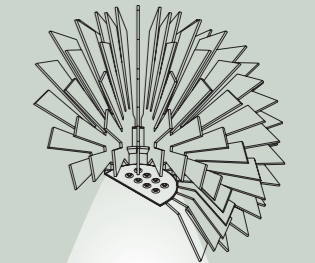

Mone W
Round L

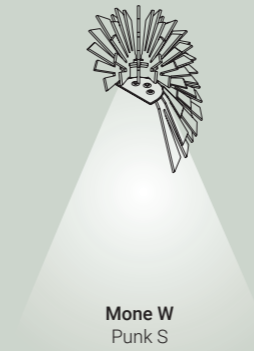

Mone W
Punk S

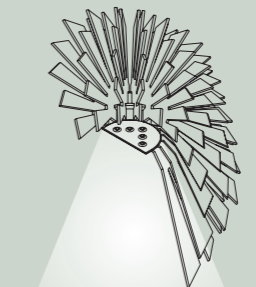

Mone W
Punk M

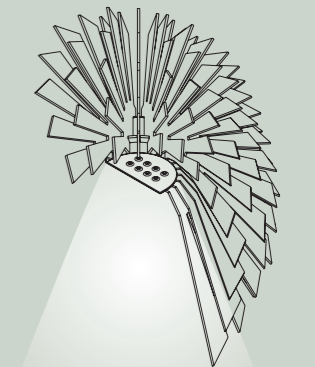

Mone W
Punk L

Mone Wall is a special version that adjusts Mone's presence and form to illuminate vertical surfaces. Though the shape is slightly changed, the sound absorption effect stays on the professional level, allowing us to further experiment with the perfect hybrid - effective, beautiful illumination and sound

absorption and most importantly Mone's edgy artistic character stays untouched and unbothered. Perfect for those who are looking to spice up their space, while still adding something functional and moreover the highest quality of light.



Mone
Flat



Acoustic comfort

The Mone Flat, designed with a low profile and a wide, sprawling structure that resembles a sleek, modern pancake. Its minimalist and understated

form emphasizes horizontal lines, creating a sense of openness and balance in any space

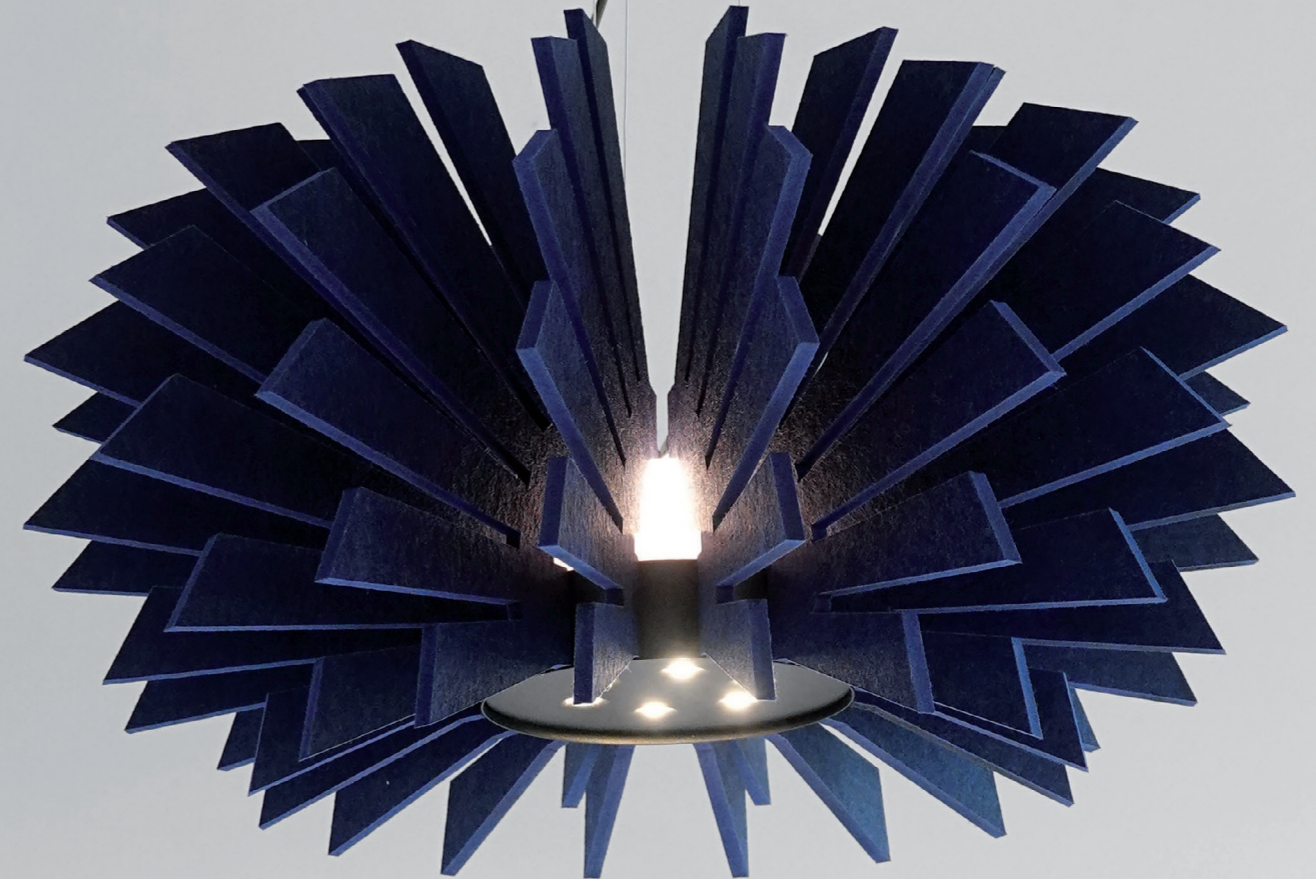

We designed a custom ceiling box specifically for the lamp, ensuring a seamless integration into the overall structure. This attention to detail resulted in a meticulously crafted product that not only functions

perfectly but also offers a refined, aesthetically pleasing design, with every aspect thoughtfully considered.

Mone | Ceiling box

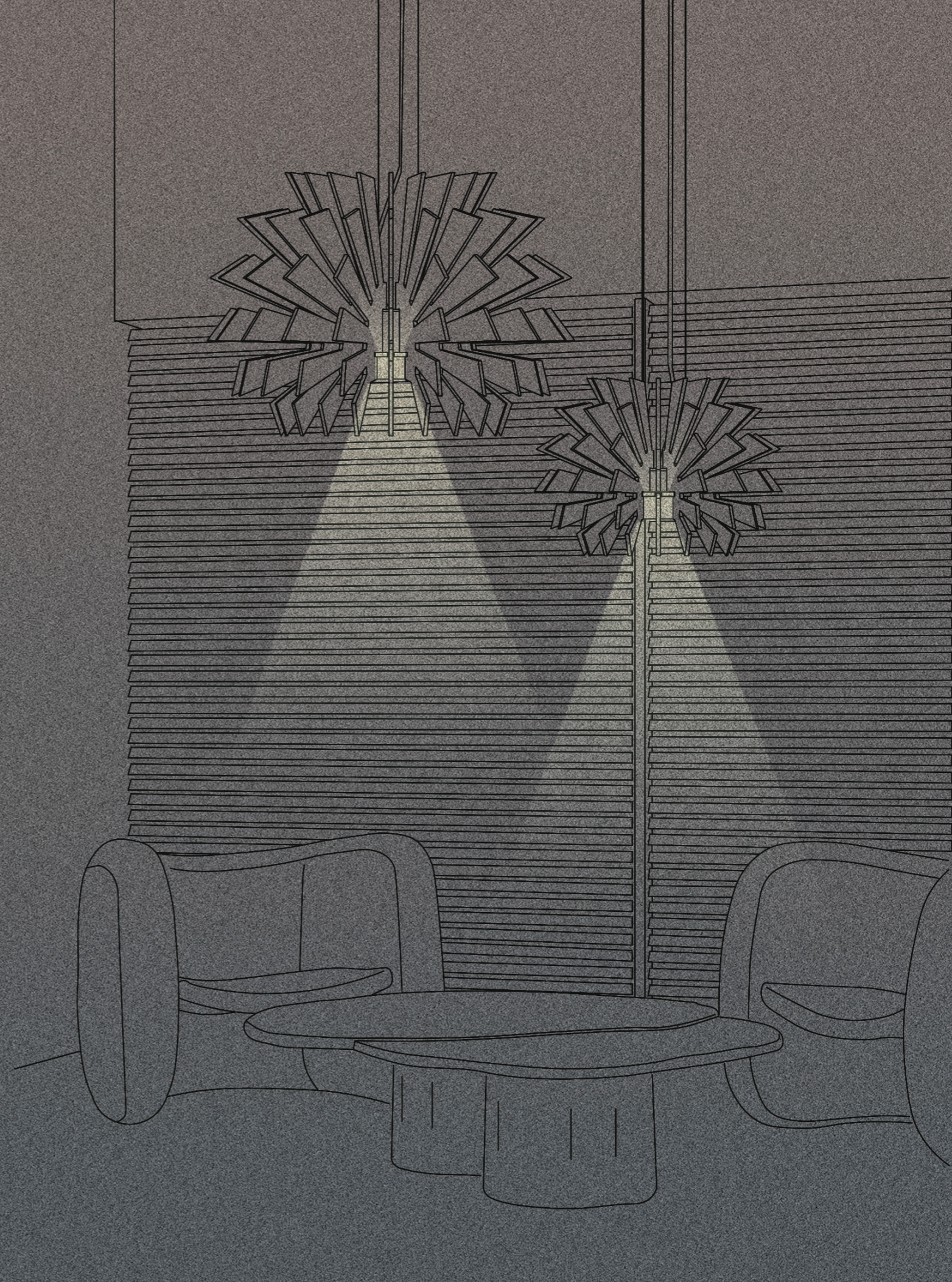

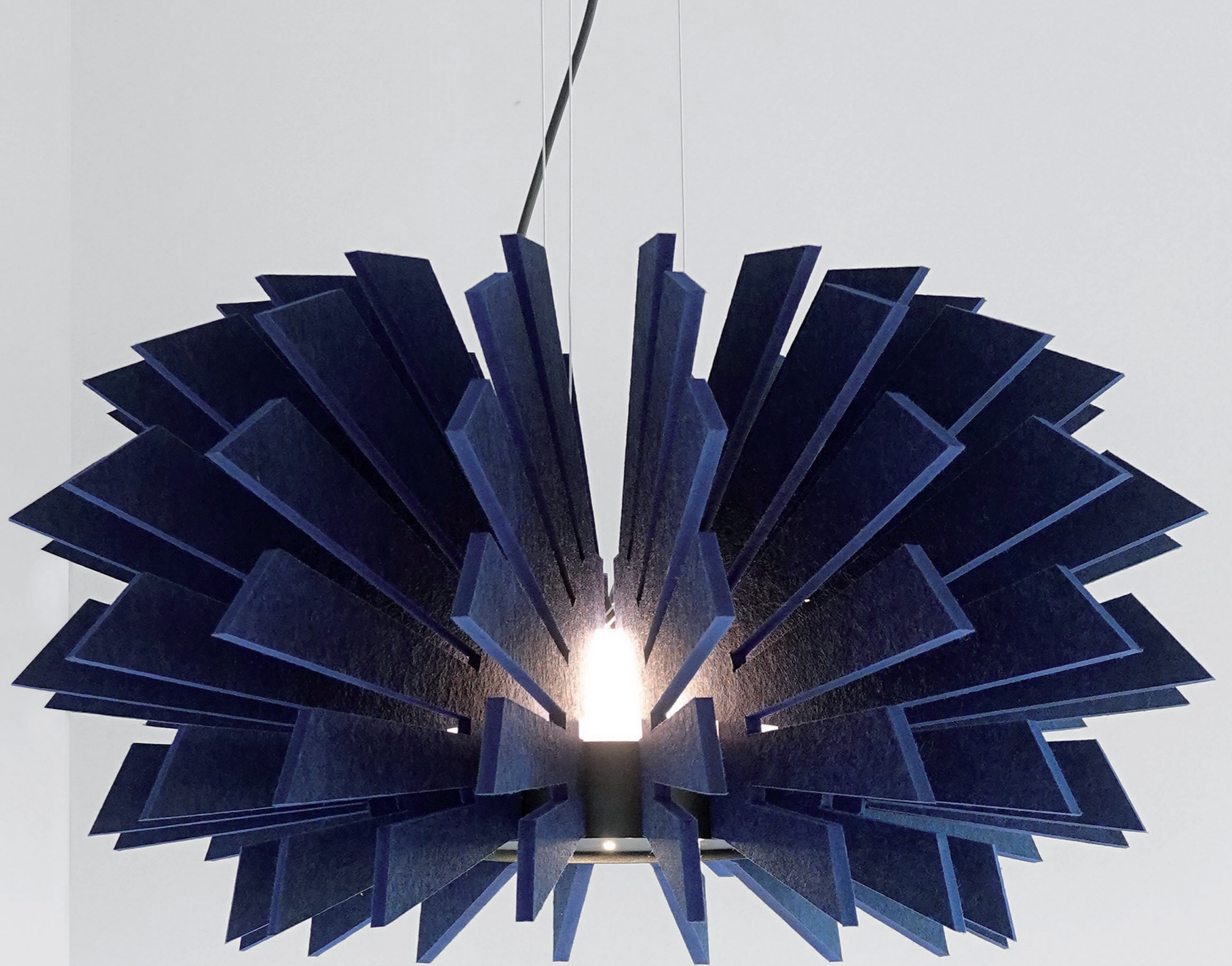

Mone, thanks to its unique ribbed structure, offers exceptional comfort in both acoustics and lighting. The innovative design, featuring multiple panels made from

high-quality PET felt, effectively absorbs sound across a wide range of frequencies, contributing to a quieter and more pleasant environment.

Mone
Oval



Acoustic comfort

The Mone Oval is an elegantly refined version of the collection, featuring a smooth, elongated shape that blends the symmetry of a circle with the dynamic flow of an ellipse. The oval design not only enhances

the lamp's aesthetic versatility but also optimizes its acoustic performance, allowing sound to travel seamlessly along its contours.





Mone | Oval M | Black



Mone
Round



Acoustic comfort

The Mone Round is a harmonious and symmetrical design, characterized by its perfectly circular form that exudes balance and simplicity. Round's clean,

minimalist design makes it a subtle yet impactful piece, ideal for creating a calming and cohesive atmosphere.





Mone
Punk



Acoustic comfort

The Mone Punk lamp stands out as the most avant-garde piece in the collection, pushing the boundaries of design with its bold and unconventional aesthetic. Its panels are meticulously arranged and crafted to evoke

the edgy, rebellious spirit of a rock-punk hairstyle. The Mone Punk is a true celebration of individuality and nonconformity, perfect for those who dare to defy the ordinary.

Orbit Round Collection

Quiet efficiency

Orbit is a perfect hybrid, connecting our own optic with the acoustic power of PET felt. Multicone on its own is a system of highly effective and efficient lenses, that we designed in a spirit of glareless, healthy

light. Created with UGR 19 Orbit fits perfectly in all the different spaces, from offices, to school classrooms. Its PET felt Orbit absorbs sound and goes after the perfect quiet atmosphere.

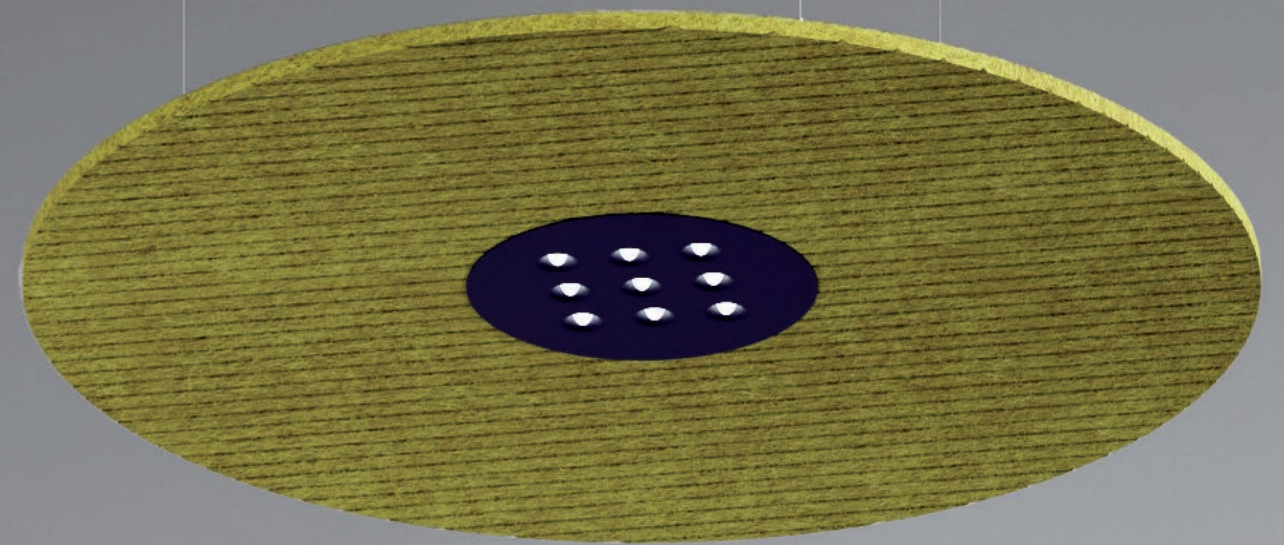

Orbit Round Collection

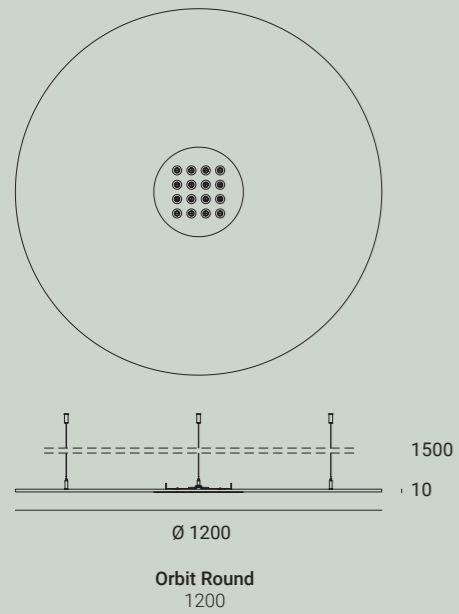
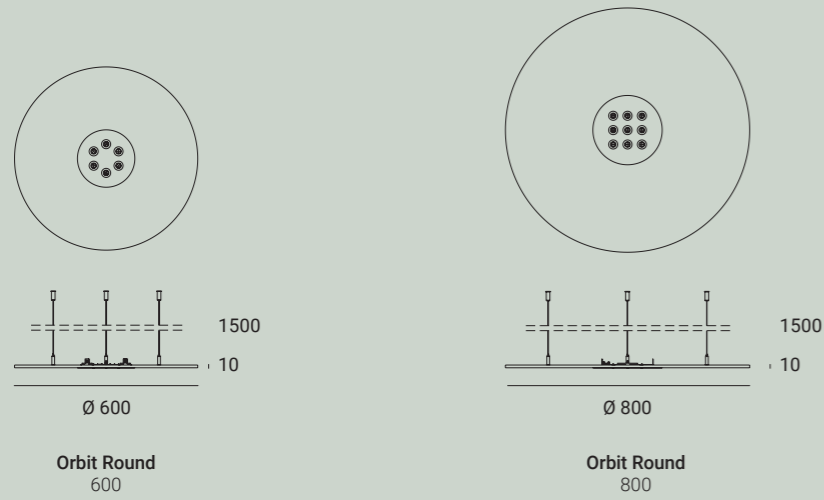

Available in three different sizes, each size with a different diameter and number of multicone lenses, allows the luminaire to fit different spaces. The PET felt orbit is very customisable and can match our space, our design, our vibe, or even our personality. There are

multiple PET felt colours to choose from and on top there is a possibility to choose either smooth finish or one of two grooving types: radial grooving or strip grooving.

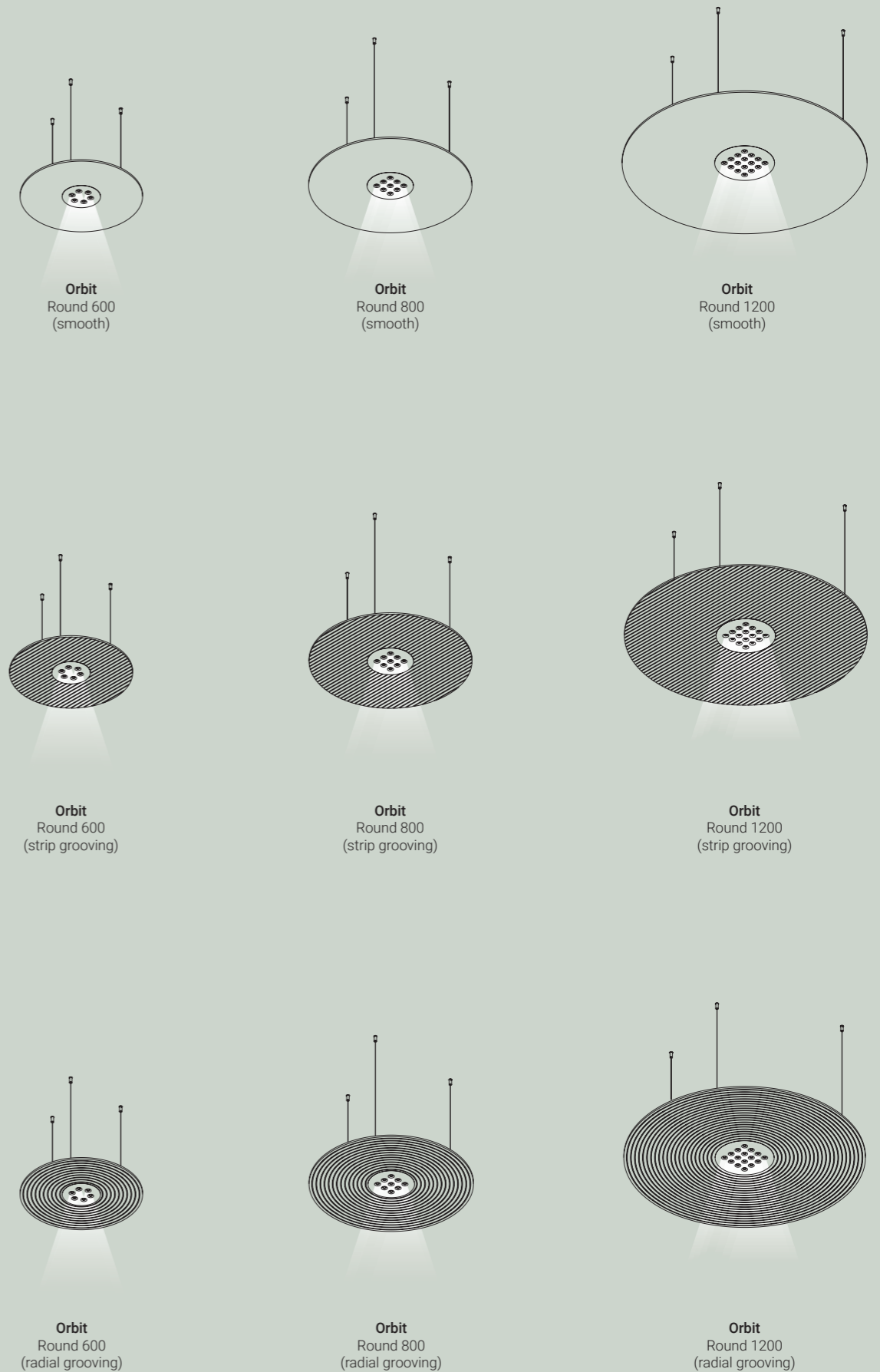

Orbit Square Collection

Edgy sibling

Sometimes the round, soft finish is not what is needed, sometimes there is a need for sharp edges and rectangular shapes. In order to fit different design styles and preferences, we created orbit not only in

the Round version, we also created the Square variant. For all those who are looking for a straight and orderly look, Orbit square came to be.



Orbit Square Collection

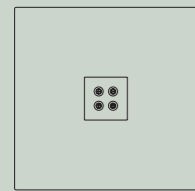

Orbit Square
600

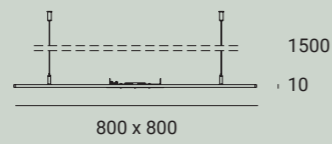
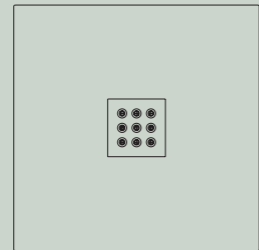

Orbit Square
800

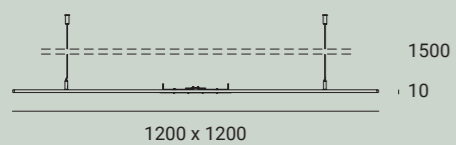
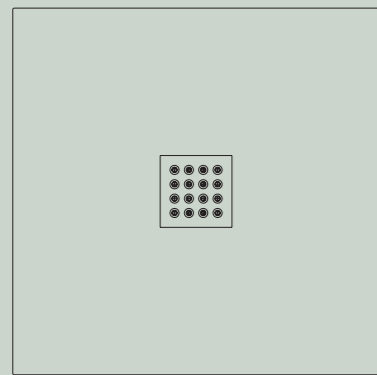

Orbit Square
1200

Also available in three different sizes, with all edges being the same length, it creates beautiful squares. Each size is equipped with a number of multicone lenses from 4 up to 16. The PET felt orbit just like in

the round version is there to suit different tastes and comes in a variety of colours. On top of that we can choose either smooth PET felt finish, or one of two groovings: strip grooving and radial grooving.

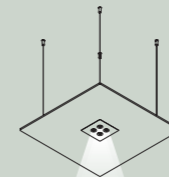

Orbit
Square 600
(smooth)

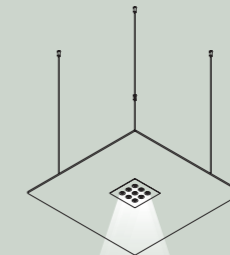

Orbit
Square 800
(smooth)

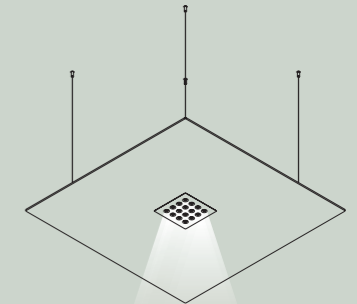

Orbit
Square 1200
(smooth)

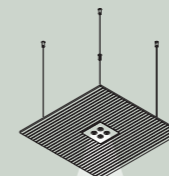

Orbit
Square 600
(strip grooving)

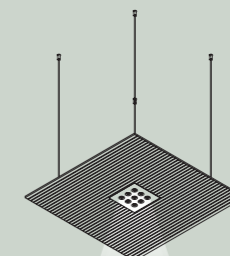

Orbit
Square 800
(strip grooving)

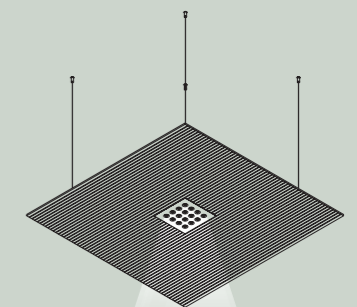

Orbit
Square 1200
(strip grooving)

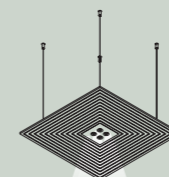

Orbit
Square 600
(radial grooving)

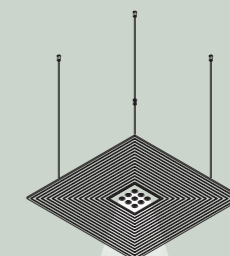

Orbit
Square 800
(radial grooving)

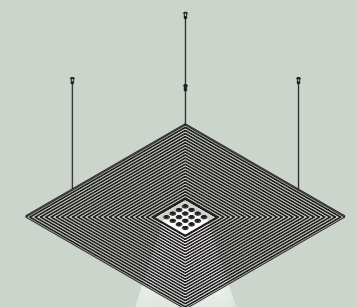

Orbit
Square 1200
(radial grooving)

Halo Round Collection

Soft and sound

An ambient light that combines the best of both worlds - beautiful soft lighting and noise absorption allowing us to create a peaceful atmosphere that warms up any

space with its calming soul. Highly customisable can vibe with all different characters and tastes.

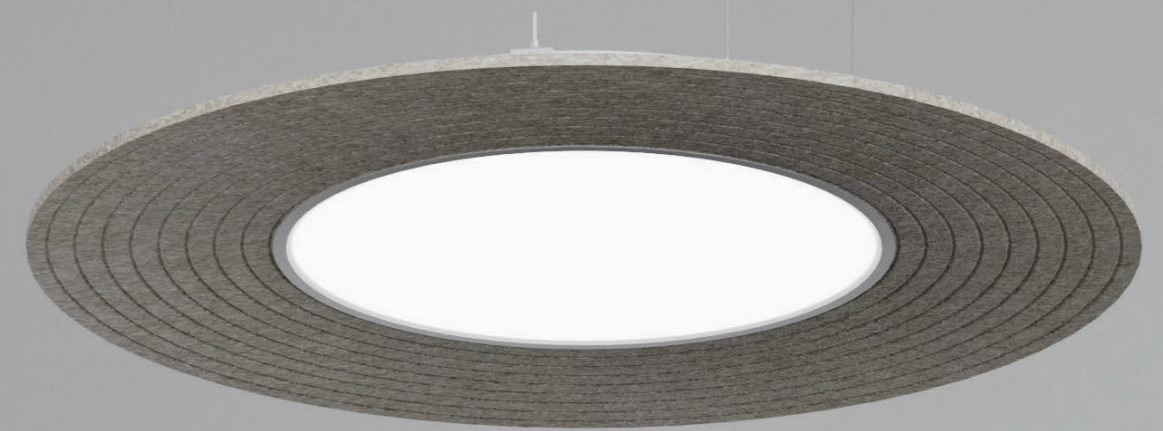

Halo Round Collection

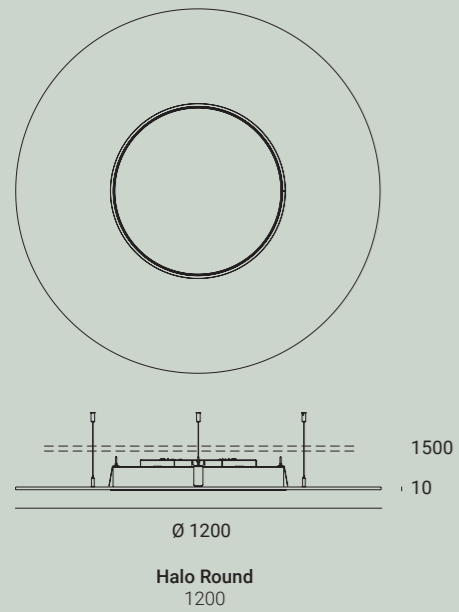
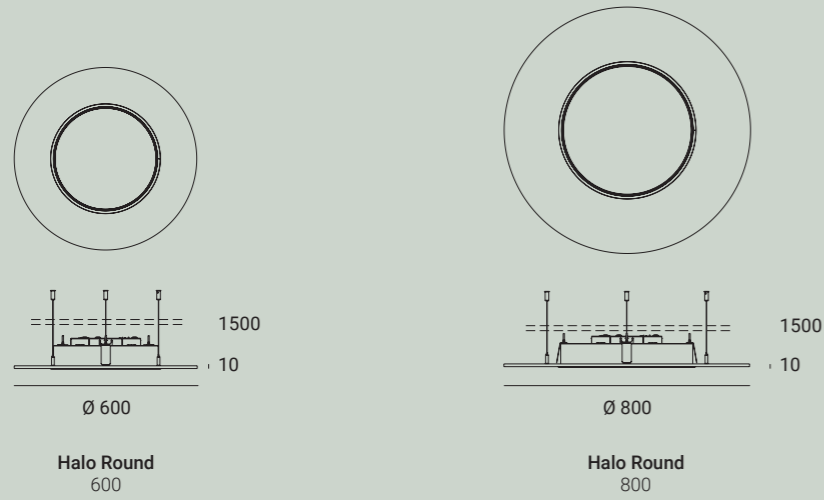

Halo Round is a suspended luminaire that is available in three different sizes, depending on the size of the Halo, the size of the light source changes accordingly. The horizontal shade of the luminaire is made out of

PET felt and comes in all sorts of different colours to choose from. Moreover the finish of the halo can be either smooth or grooved in two different ways: strip grooving or radial grooving.

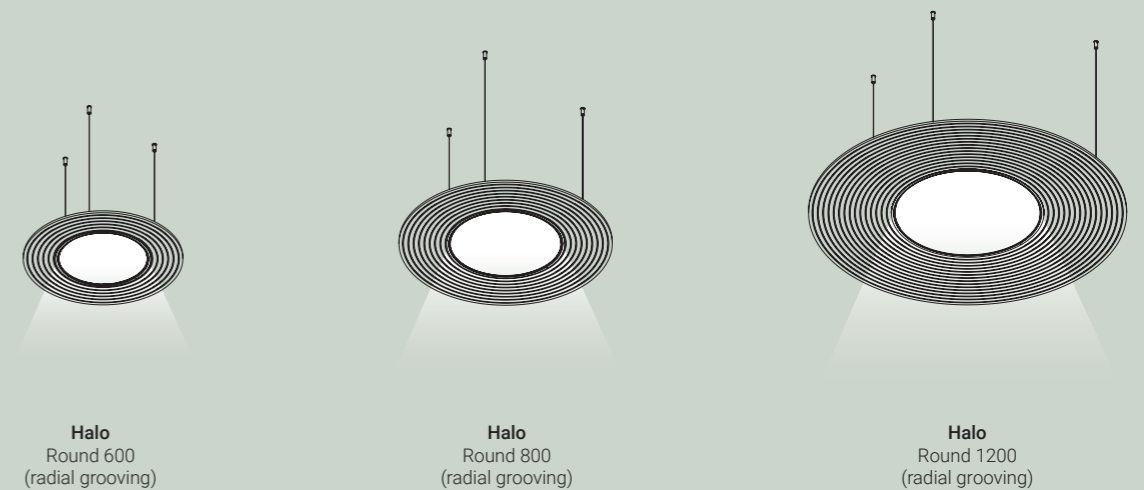
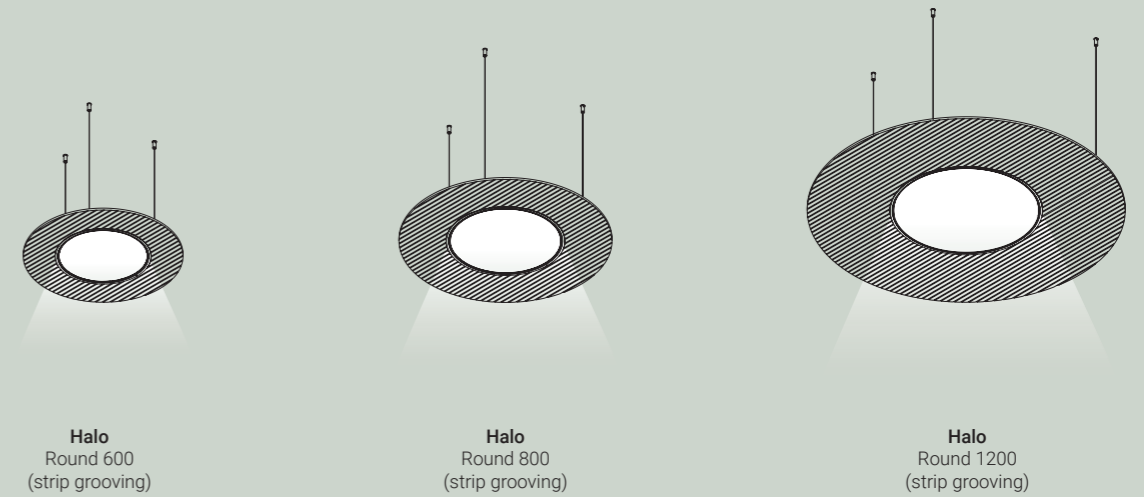
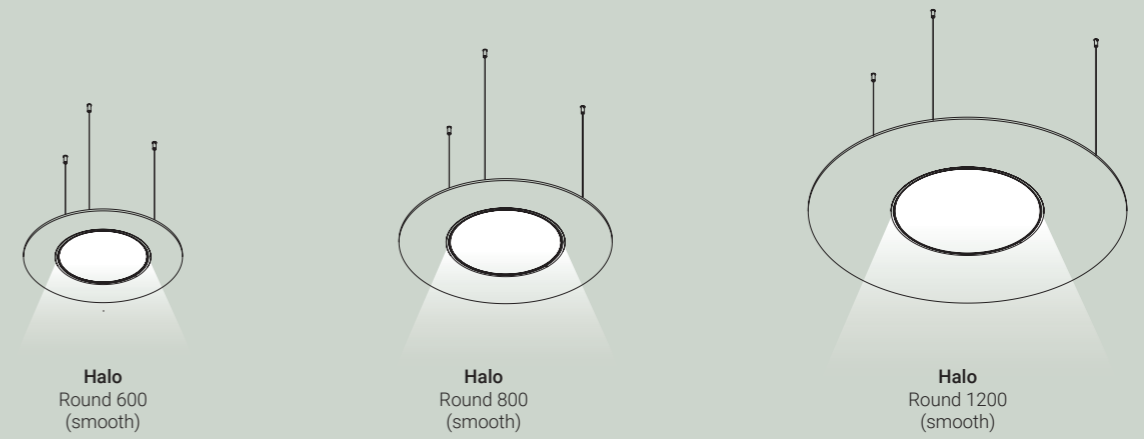

Halo Square Collection

Structured serenity

By substituting soft curves with straight edges and 90 degree angles Halo square was created. In contrast to its sibling, this variant radiates elegant and classic

vibe. Created for spaces that are looking for peace and quiet combined with beautiful ambient lighting with an orderly character.

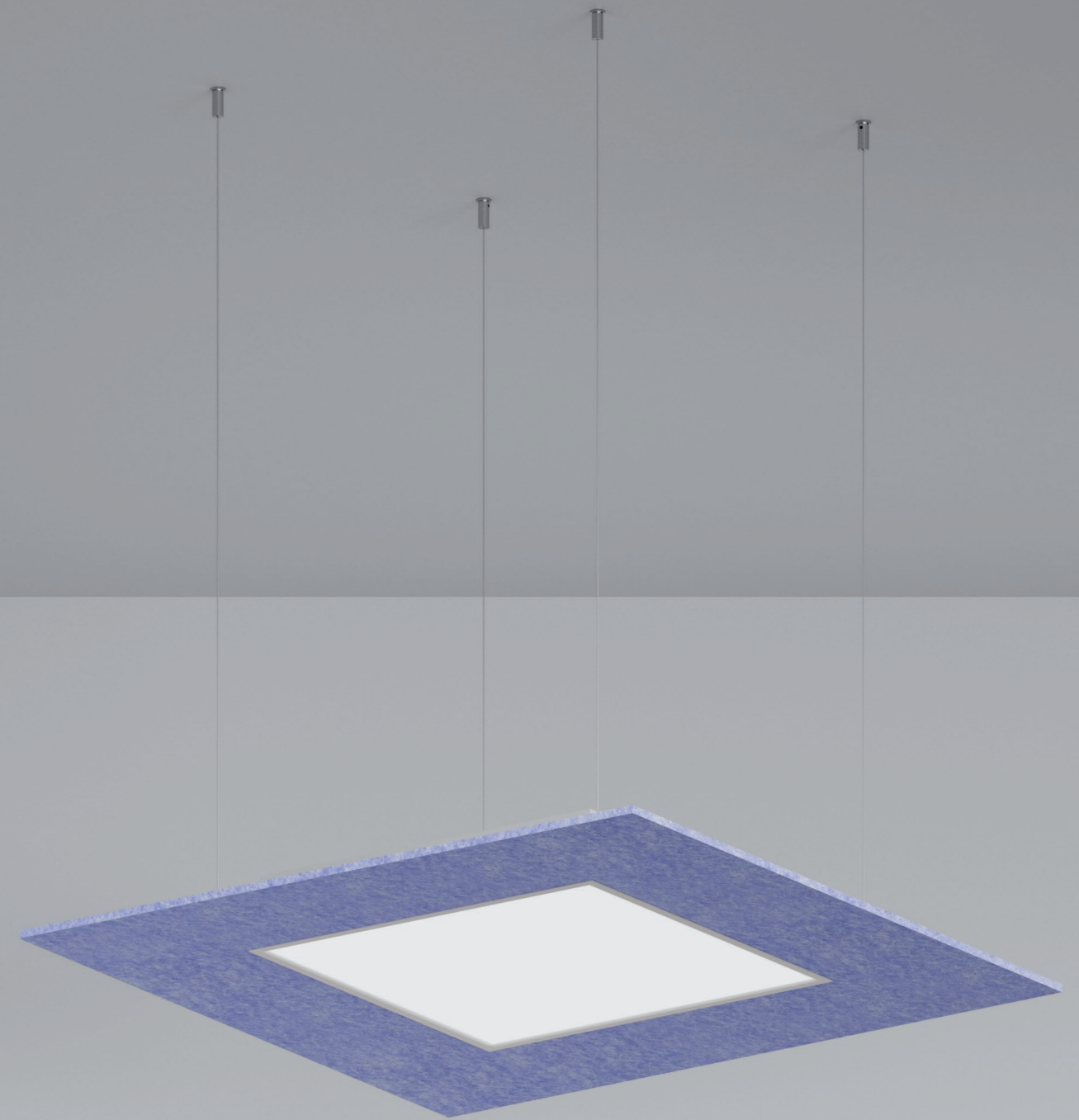

Halo Square Collection

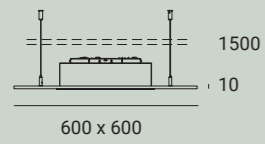
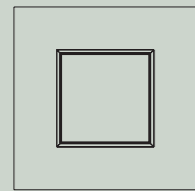

600 x 600

Halo Square
600

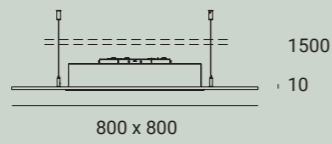
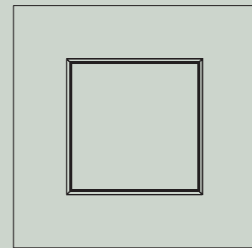

800 x 800

Halo Square
800

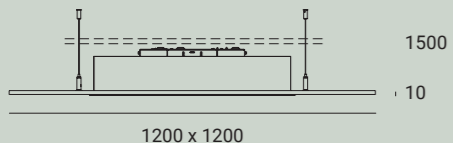
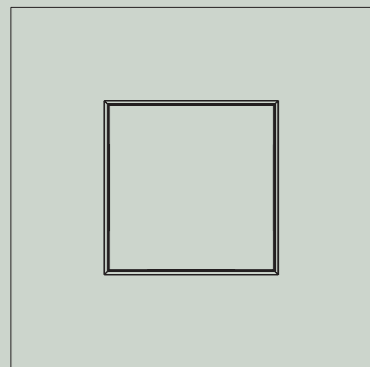

1200 x 1200

Halo Square
1200

Halo Square is a suspended luminaire that is available in three different sizes, depending on the size of the Halo, the size of the light source changes accordingly. The horizontal shade of the luminaire, made out of

PET felt comes in all sorts of different colours to choose from. Moreover the finish of the halo can be either smooth or grooved in two different ways: strip grooving or radial grooving.

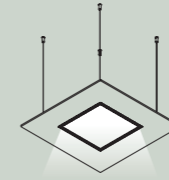

Halo
Square 600
(smooth)

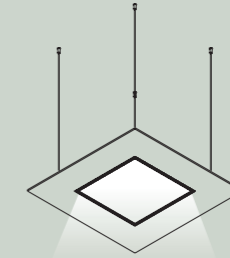

Halo
Square 800
(smooth)

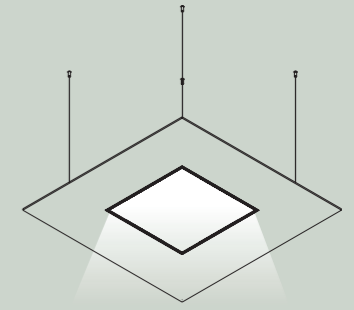

Halo
Square 1200
(smooth)

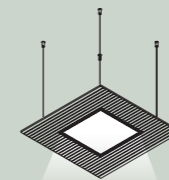

Halo
Square 600
(strip grooving)

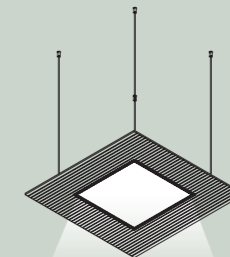

Halo
Square 800
(strip grooving)

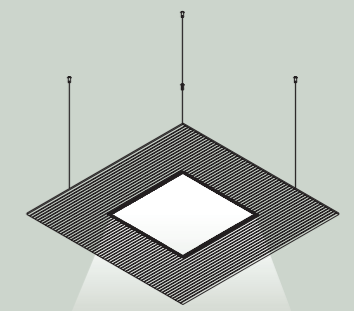

Halo
Square 1200
(strip grooving)

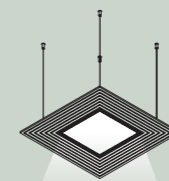

Halo
Square 600
(radial grooving)

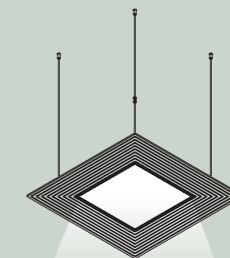

Halo
Square 800
(radial grooving)

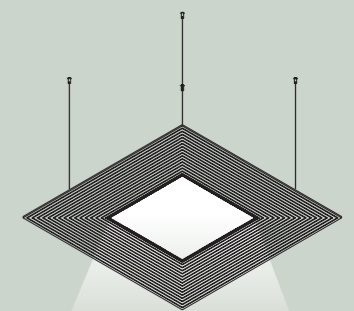

Halo
Square 1200
(radial grooving)

Peaceful silence

Turbo is a luminair that through its construction and lightsource creates a peaceful atmosphere. It creates a well lit area and with its soft light any space can be

warmed up. Moreover Turbo not only creates beautiful illumination, thanks to its PET felt shade it can absorb sound and pursue silence in even the busiest spaces.



Turbo Collection

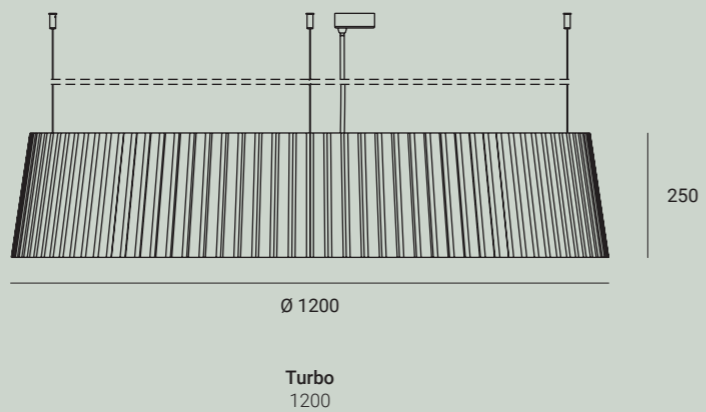
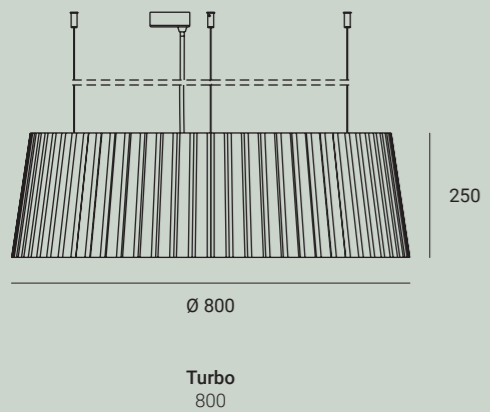
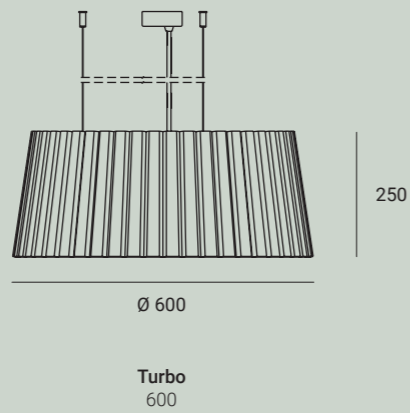
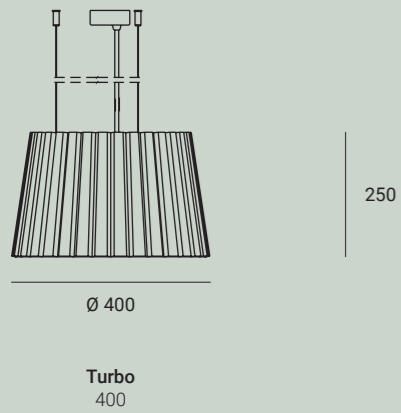

Available in four sizes Turbo fits in both homely and business spaces, and especially there where we are looking for both soft light and noise absorption. The luminair can be customised through a variety of

diffusers, each one giving slightly different finish both when the light is on and when it is off. Furthermore the shade is made out of PET felt, that is available in multiple colours, to fit with all different designs.

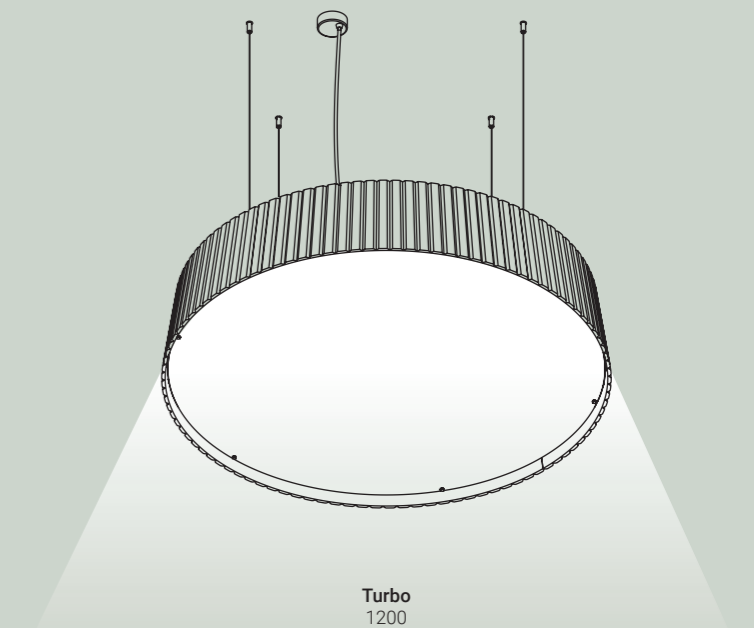
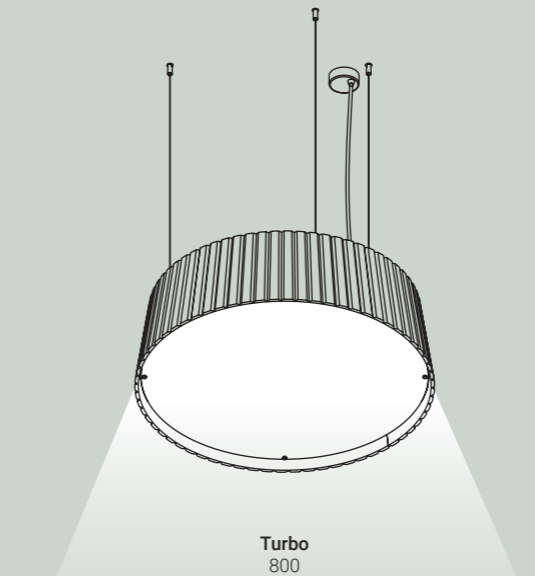
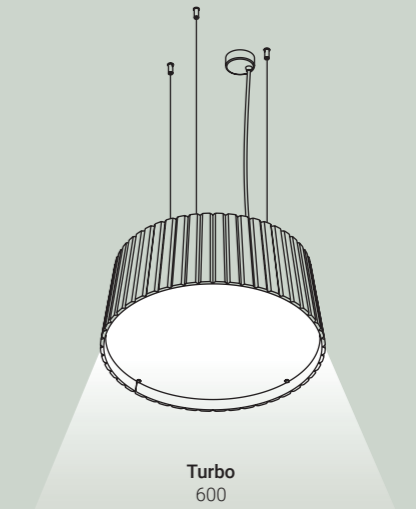
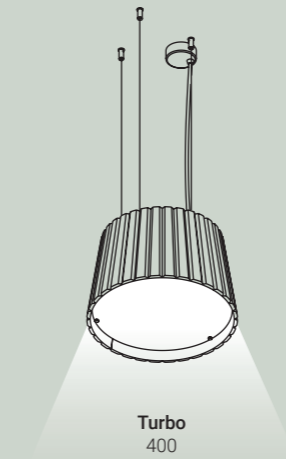

Acoustic comfort

Sonic is an innovative extension of the Snake system that enhances its functionality by incorporating acoustic panels made of lightweight, eco-friendly EcoBoard material. These panels are not only resistant to mechanical damage but also exhibit a high sound

absorption coefficient. As a result, Sonic Acoustic performs exceptionally well in open spaces and offices, creating a pleasant and ergonomic work environment.



Sonic Collection

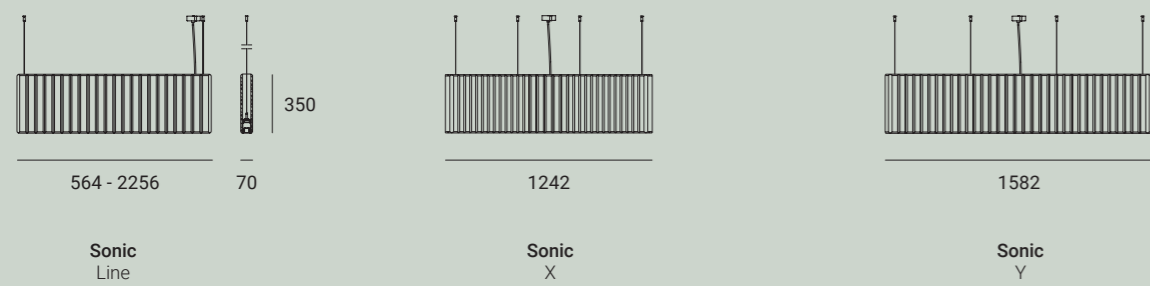
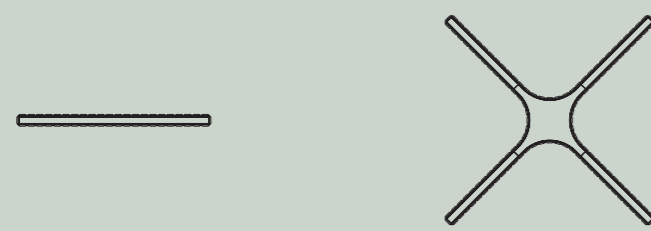
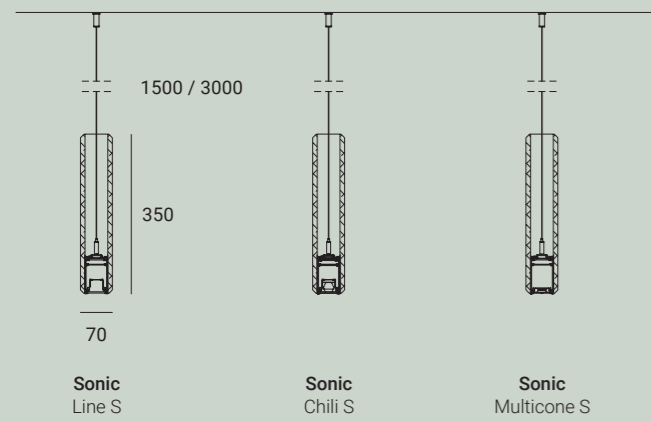

Various shapes and sizes of Sonic Acoustics have been designed to accommodate a wide range of spaces. Utilize them freely to enhance acoustic

comfort in hallways, dining rooms, and other open areas.



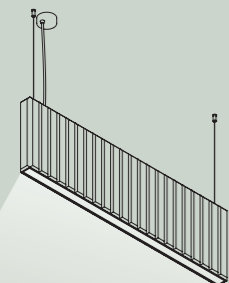

Sonic
Line

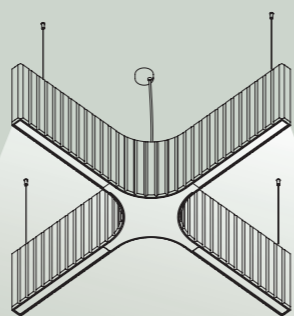

Sonic
X

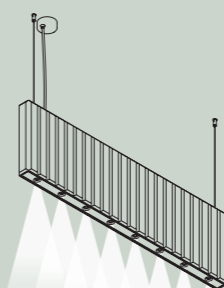

Sonic
Line Multicone

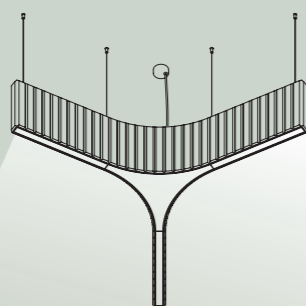

Sonic
Y

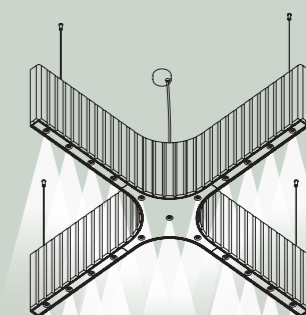

Sonic
X Multicone

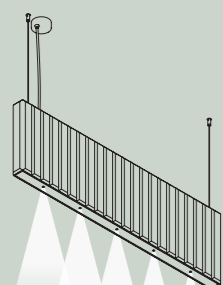

Sonic
Line Chili

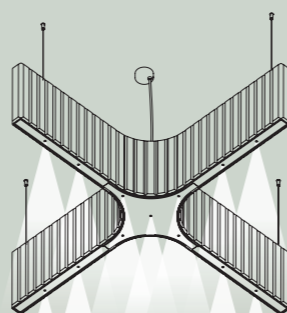

Sonic
X Chili

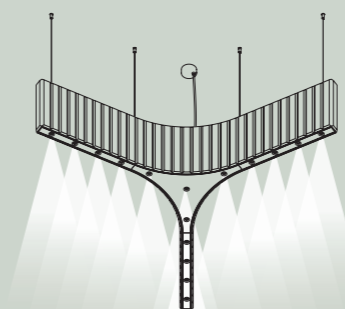

Sonic
Y Multicone

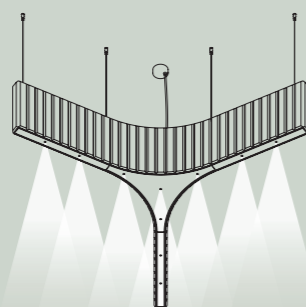

Sonic
Y Chili

Ready made solutions

We've ensured that our acoustic lamps seamlessly integrate into interiors. Our diverse range of lamps is designed to complement any space effortlessly. Building upon the excellence, we've incorporated various light diffusers and cutting-edge technology

for easy assembly, enhancing them with premium acoustic ecomaterials. We also made sure its easy to use, chose the ready made sollution from our catalogue or webside and forget about using online tools or combining modules on paper.

Sonic | PET felt panels 35 cm

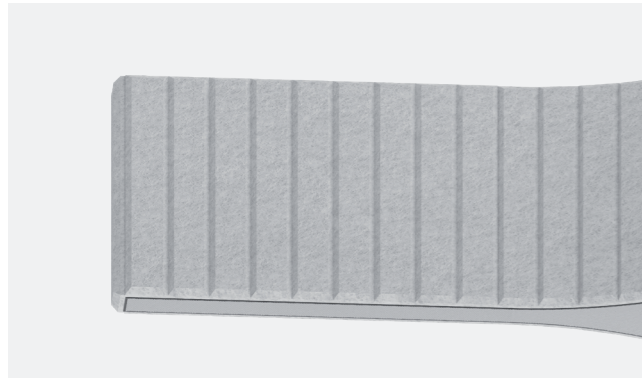

Sonic | Opal

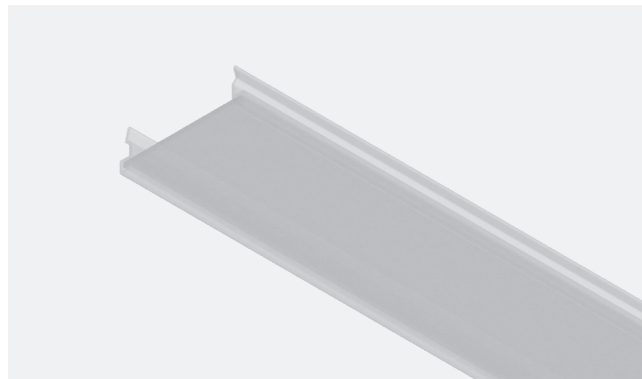

Sonic | Opal Microcrystal

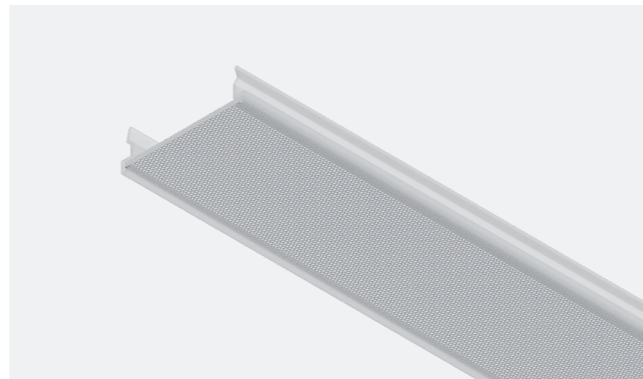

Sonic | Dark Microcrystal

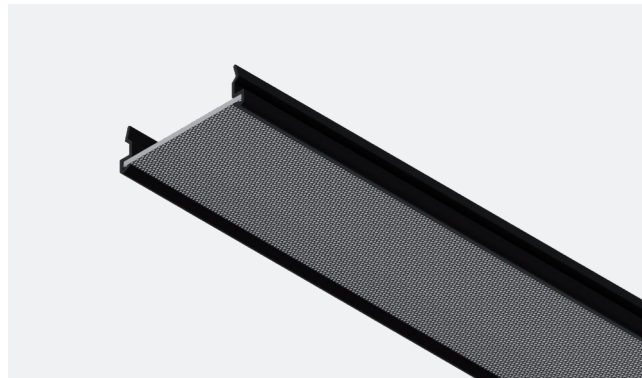

Sonic | Chili



Sonic | Multicone



We've utilized 35 cm PET felt panels to ensure that your space meets acoustic standards. These panels are crafted from fibers derived from recycled plastic bottles, making them an eco-conscious choice. The material is not only environmentally friendly but

also safe for human health. It boasts odor resistance, resilience against mold, damage, and deformation, while also being free from harmful substance emissions.

Sonic Oval Collection

Acoustic comfort circular

Sonic Oval is an innovative solution, featuring a sleek ring design that enhances both aesthetics and functionality in various settings such as open workspaces, meeting rooms, and dining areas. Its seamless integration with work desks

and dining tables not only enhances the ambiance but also effectively minimizes noise disturbances. The combination of superior lighting and soundproof panels ensures a conducive environment for productivity and comfort.



Sonic Oval Collection

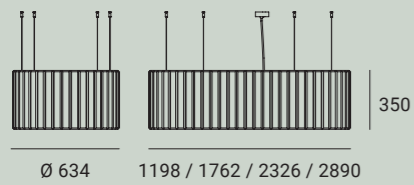
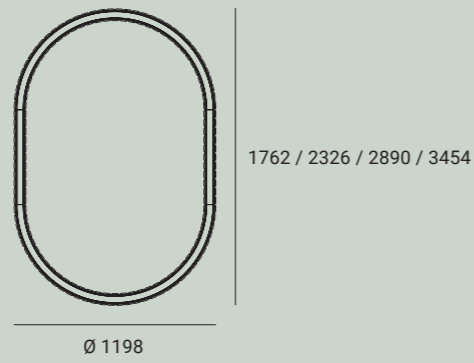
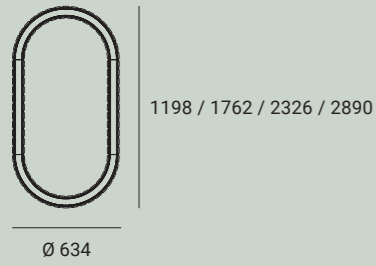
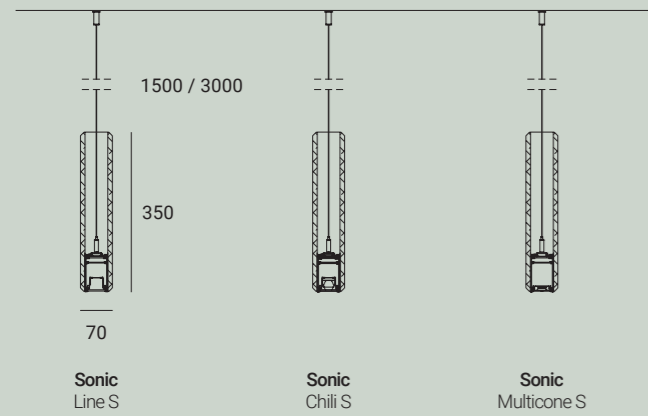

Sonic Oval Side S
Ø 634

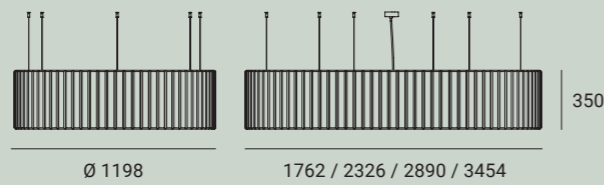

Sonic Oval Side S
Ø 1198

Available with three different lighting types, Sonic Oval can find itself in any space, whatever is needed of it. Starting with classic line lighting, we have three different diffuser types to choose from: opal, microcrystal opal and dark microcrystal, all of which

supply the highest quality of light, but with slightly different finishes. If we are looking for projector lighting we can go either for chili lenses or multicone lenses, both creating beautiful and highly efficient lighting.



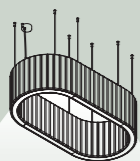

Sonic Oval
1198

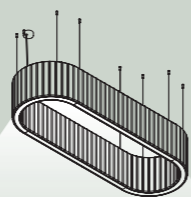

Sonic Oval
1762



Sonic Oval chili
1198



Sonic Oval chili
1762

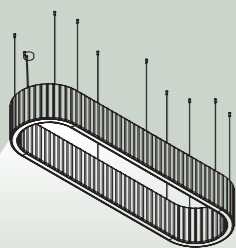

Sonic Oval
2326

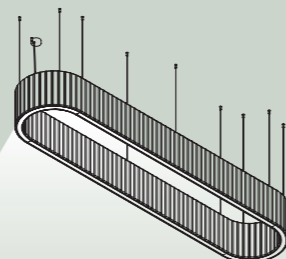

Sonic Oval
2890

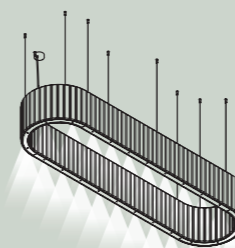

Sonic Oval chili
2326

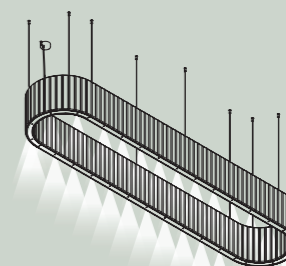

Sonic Oval chili
2890

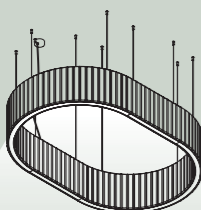

Sonic Oval
1762

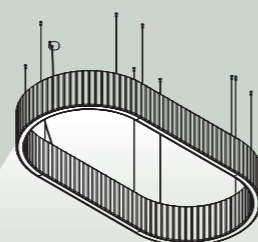

Sonic Oval
2326

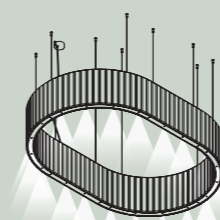

Sonic Oval chili
1762

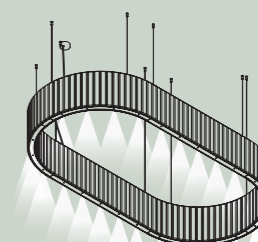

Sonic Oval chili
2326

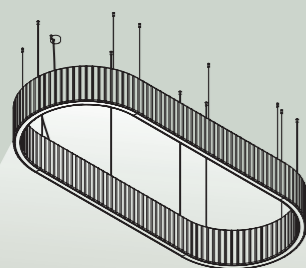

Sonic Oval
2890

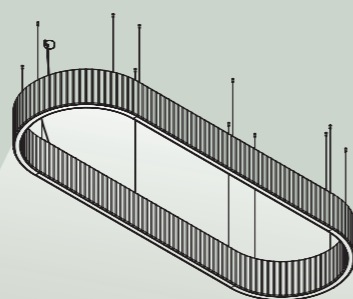

Sonic Oval
3454

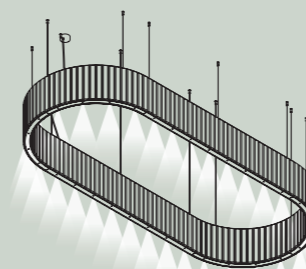

Sonic Oval chili
2890

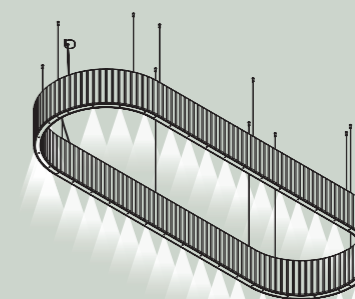

Sonic Oval chili
X454



Sonic Oval multicone
1198

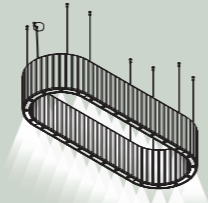

Sonic Oval multicone
1762

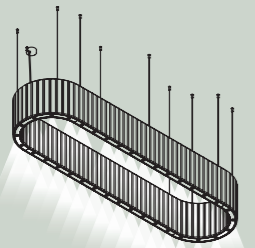

Sonic Oval multicone
2326

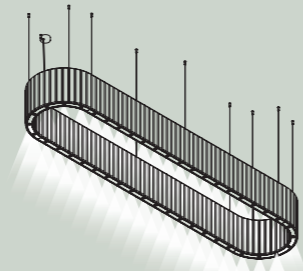

Sonic Oval multicone
2890

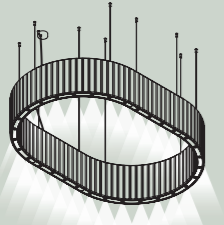

Sonic Oval multicone
1762

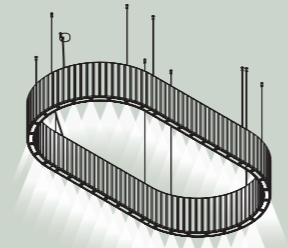

Sonic Oval multicone
2326

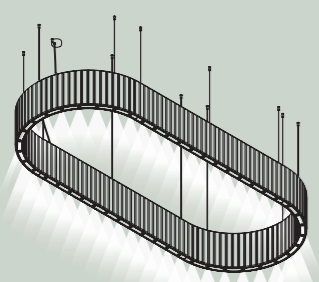

Sonic Oval multicone
2890

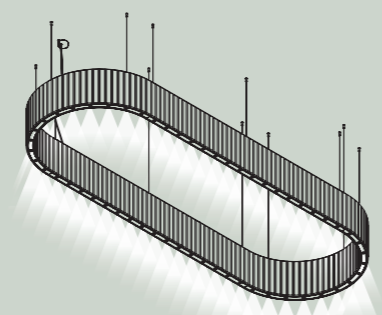

Sonic Oval multicone
3454

Sonic | PET felt panels 35 cm

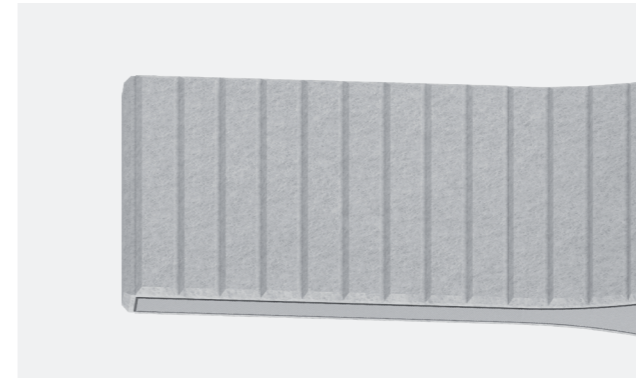

Sonic | Opal

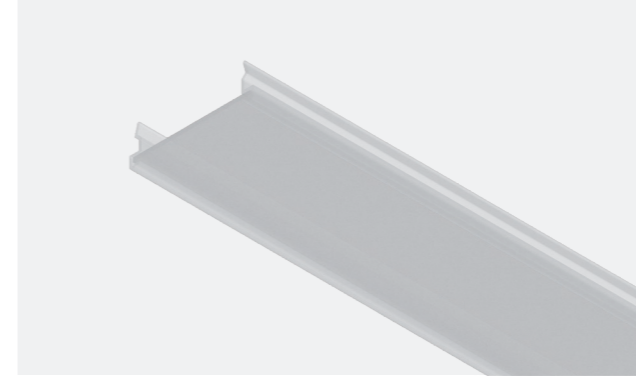

Sonic | Opal Microcrystal

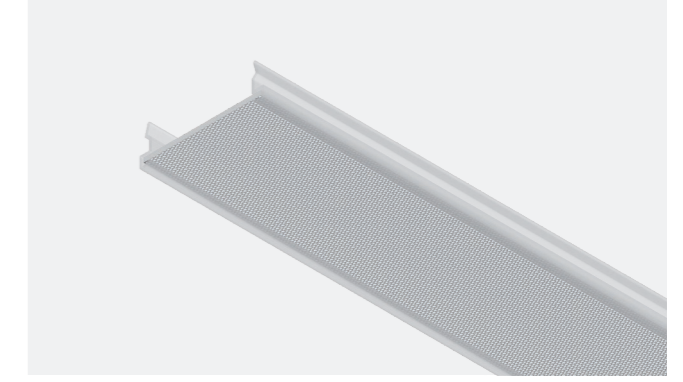

Sonic | Dark Microcrystal

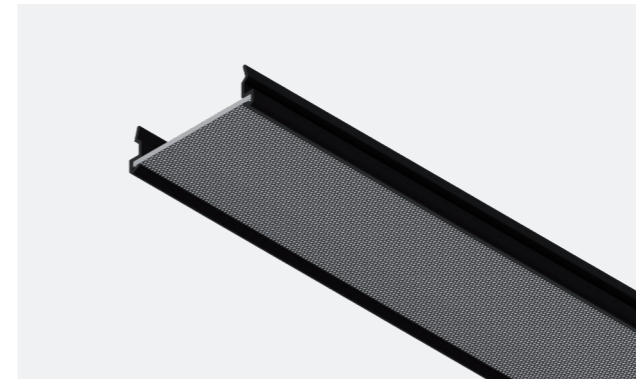

Sonic | Chili

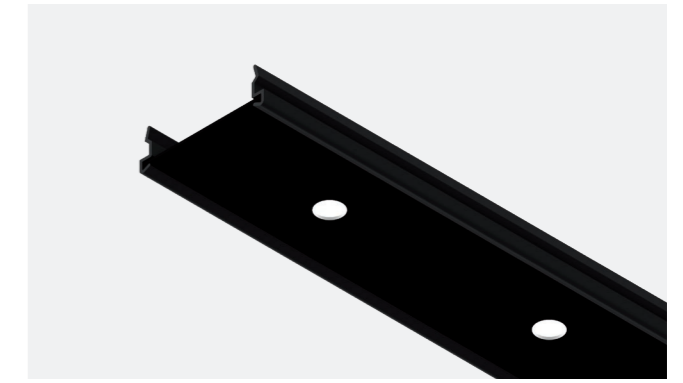

Sonic | Multicone



Source of silence

A perfect solution for office open space, or any other place, where we are looking for a comfortable working atmosphere. This luminair combines in its slim, elegant body the power of healthy, efficient light with

acoustic technology, making it a two in one solution. Highly efficient, providing best light quality combined with PET felt finish, makes EVEN not only a source of light but also a source of silence.



Even Collection

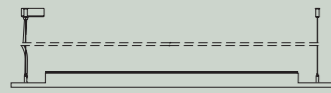
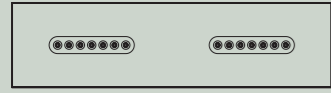

1128

Even C/S
1128



300 | 55

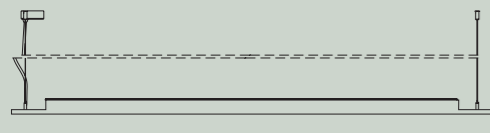

1692

Even C/S
1692

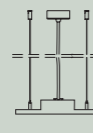

300 | 55

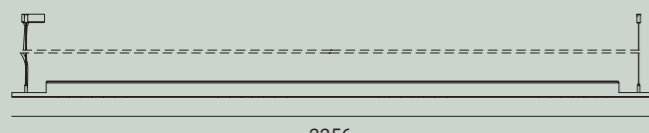

2256

Even C/S
2256

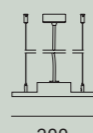

300 | 55

Even is equipped with multicone lenses, which are an optic designed by our team and developed with special technology and focus on proficiency. Available in three different lengths, each one with a number of multicone

lenses carefully chosen for the most effective and healthy light. The PET felt front finish is available in a variety of colours, which allows us to create our own design that will fit the space perfectly.

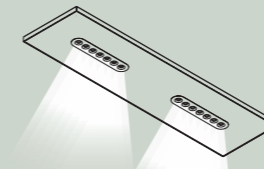

Even C
1128

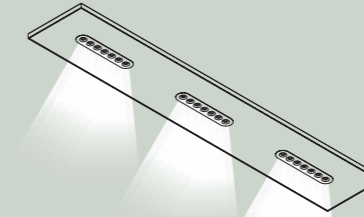

Even C
1692

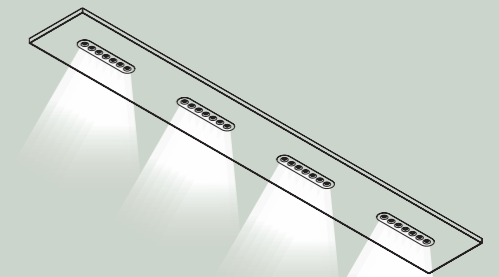

Even C
2256

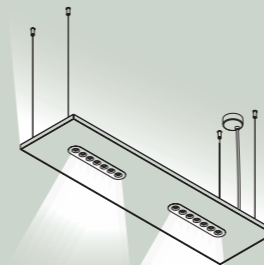

Even S
1128

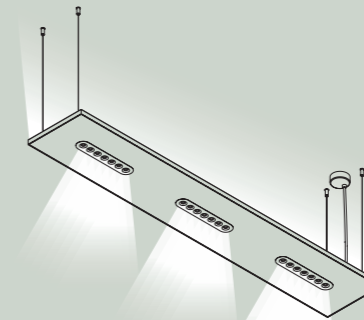

Even S
1692

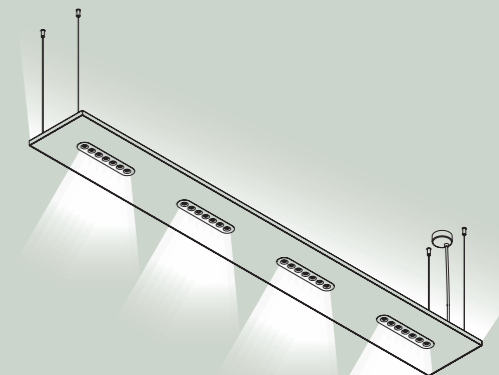

Even S
2256

The Pulse Shaped by Sound

The Ampra is a sculptural wall luminaire that combines lighting functionality with advanced sound-absorbing performance. Its three-dimensional, wave-shaped panels create a dynamic visual structure while effectively reducing echo and improving acoustic comfort in the room. The central light source provides an even, calm glow that enhances the organic form and adds depth to the composition.

Crafted from lightweight acoustic materials, the system is designed to optimize sound absorption and visual impact at once. Each panel is precisely layered to achieve a balance of form and function, resulting in a harmonious integration of lighting, acoustics, and contemporary design—ideal for hospitality spaces, residential interiors, and modern workplaces.



Ampra Collection

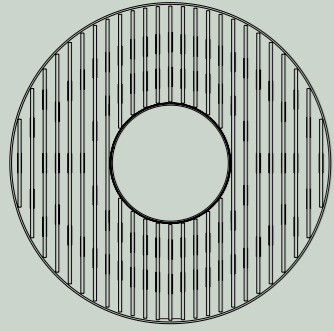

920



170

Ampra

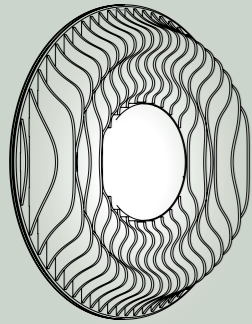

The distinctive wave pattern of Ampra is formed from precision-cut PET felt, creating a layered surface that flows seamlessly across the fixture. The soft, sculptural curves enhance visual depth while naturally diffusing sound within the room. Their interplay of convex and concave forms introduces a gentle rhythm that draws the eye and enriches the surrounding

architecture. Thanks to the resilient structure of PET felt, the waves maintain their shape over time, offering both acoustic support and a refined tactile character. This combination of form, texture, and material intelligence gives Ampra its calm, sophisticated presence in any interior setting.



Acoustic System

The Foamy Acoustic System embodies the essence of nature and soft illumination. This collection comprises wall panels, offered in a diverse range of colors. Its inner acoustic filling not only achieves carbon neutrality but also boasts breathability and

biodegradability, ensuring top notch sound absorption rated at A class. Each panel is gently lit by ambient light creating a soft and gentle atmosphere. These panels can be installed individually, integrated into a cohesive system for walls.



Foamy Collection

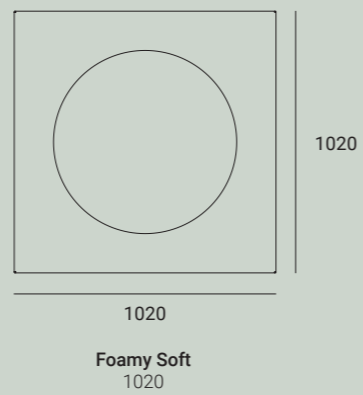
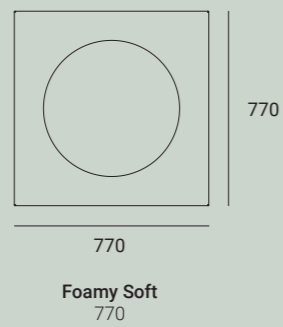
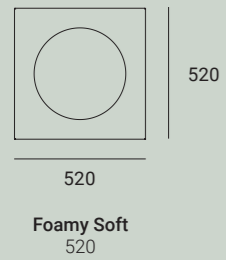
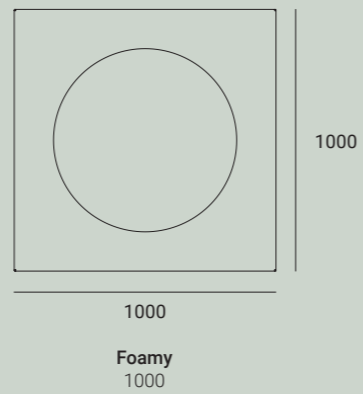
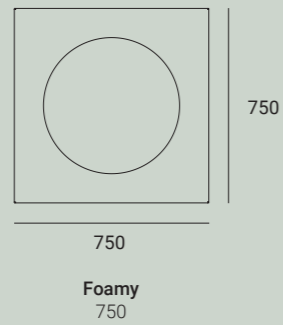
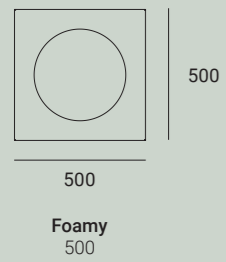

Foamy proves to be an exceptional tool for not only enhancing acoustic comfort but also for introducing a soothing ambiance with its gentle lighting.

Its versatile panels offer flexibility, allowing for mounting on walls.



Foamy Collection

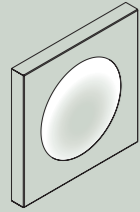

Foamy
500 x 500

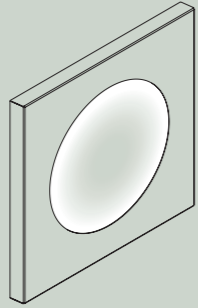

Foamy
750 x 750

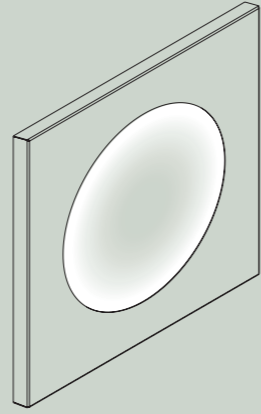

Foamy
1000 x 1000

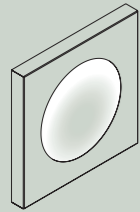

Foamy Soft
520 x 520

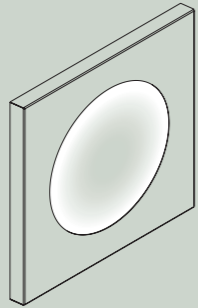

Foamy Soft
770 x 770

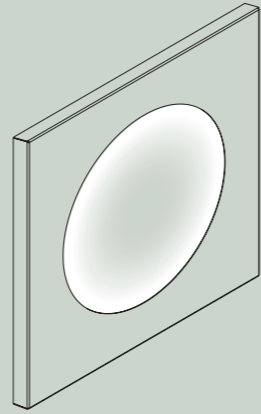

Foamy Soft
1020 x 1020

Technical Features

For Foamy acoustic filling, is carbon neutral, without using carbon offsets. The acoustic classification is

selected according to the layer thickness. Our 35 mm acoustic filling provides Class A absorption.

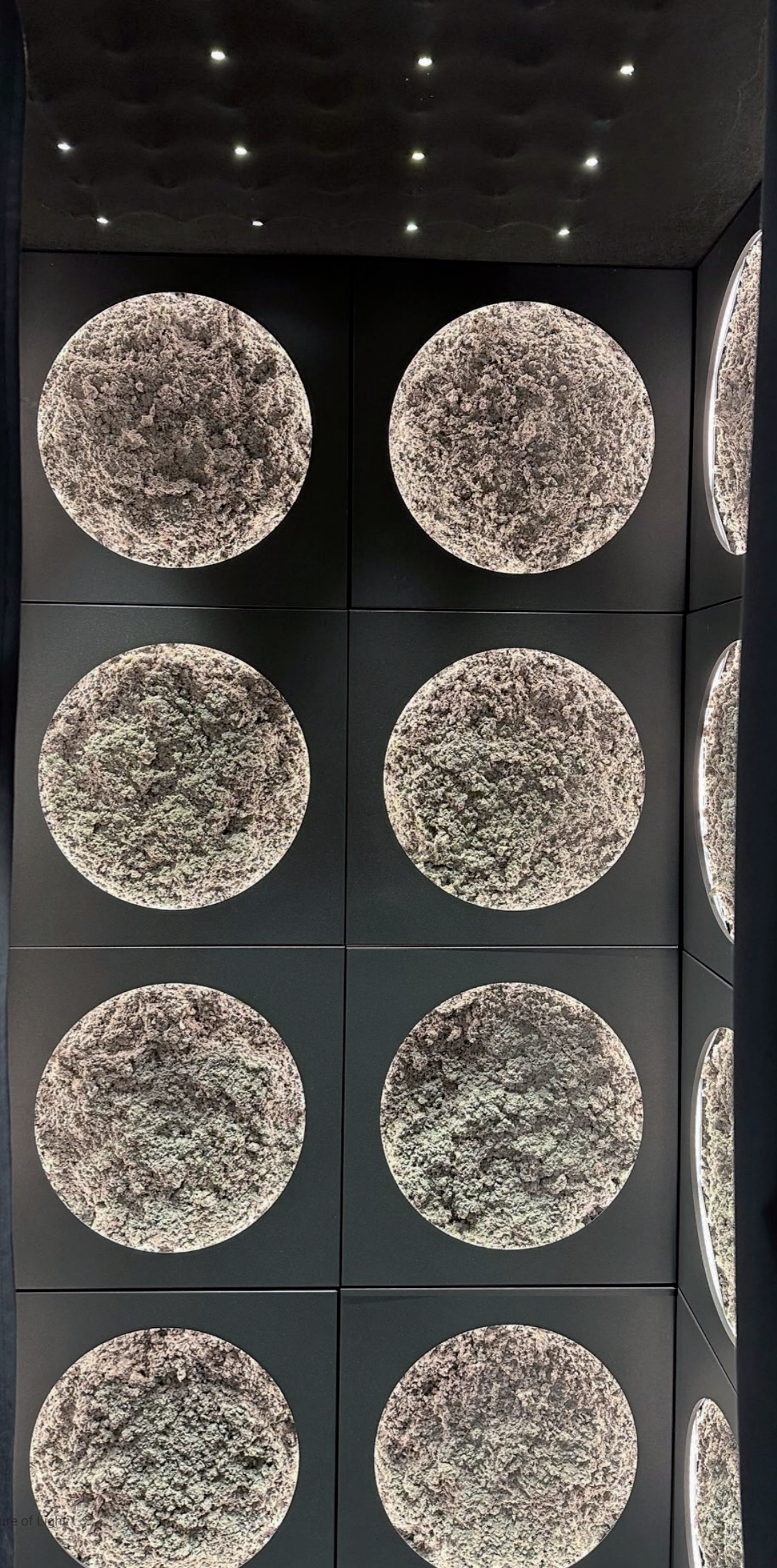

Colors

Basic



White (RAL9016)



Fog (RAL7038)



Graphite (RAL7024)



Black (RAL9005)

Standard



Sapphire (RAL5003)

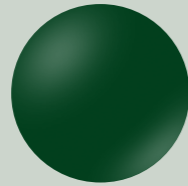

Forrest (RAL6005)

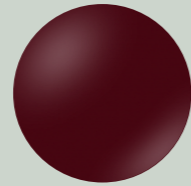

Wine (RAL3005)

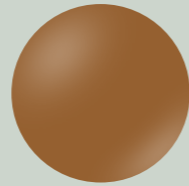

Ochra (RAL 8001)

Premium (Metalic)



Sandy

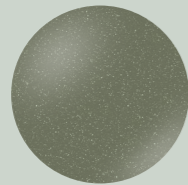

Sage

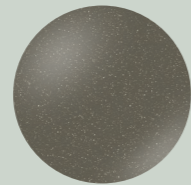

Earth

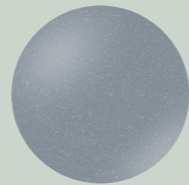

Cloudy

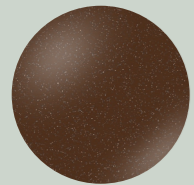

Marrone

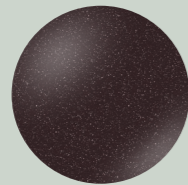

Volcano

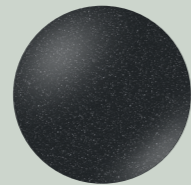

Night

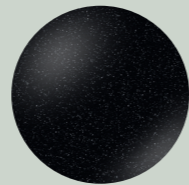

Black dust

Seasonal

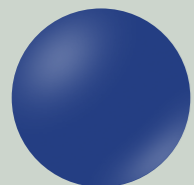

Indigo (RAL5002)

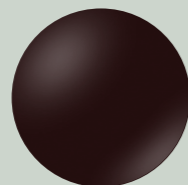

Chocolate (RAL8017)

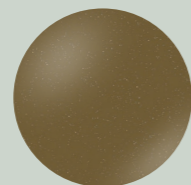

Straw (RAL 1036)



Olive (RAL6003)

PET felt



White



Camel

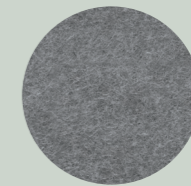

African grey

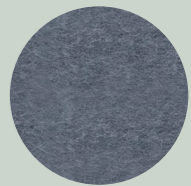

Iron

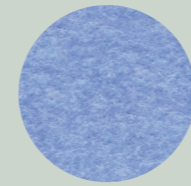

Light sky blue

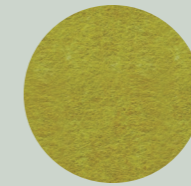

Mustard

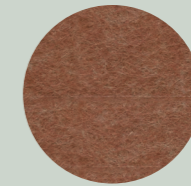

Brown



Ruby

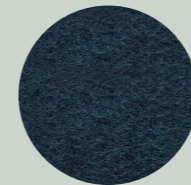

Blackish green

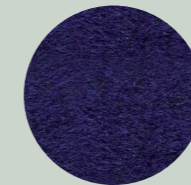

Dark blue

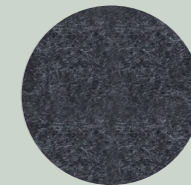

Dark grey

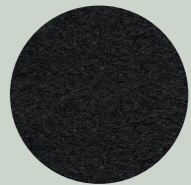

Black

To simplify the decision and the purchasing process, the Ilum offer has been extended to include the possibility to order sample sets of the available finishing materials. As a result, the User is able to see and compare colours and textures available in the Ilum offer to perfectly match the ordered lamp to the interior.



ILUM

ul. 1 Maja 46a
05-555 Tarczyn, Poland
tel: +48 22 736 73 00
info@ilum.lighting
ilum.lighting

